

WINLED  
Más que Iluminación

ar7lite  
ILUMINACIÓN LED

# CATÁLOGO 2023

i l u m i n a c i ó n l e d

2 d a . E D I C I Ó N





Duo Pack

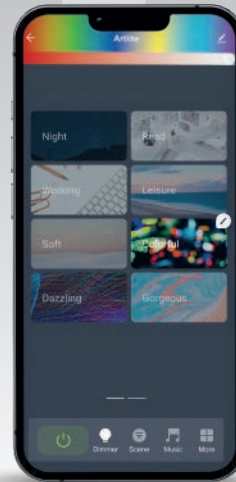

Duo Pack

## ALA-029

LÁMPARA LED SMART WIFI Y BLUETOOTH E26  
10W RGB CW MULTICOLOR Y BLANCOS ATENUABLES



-  BULBO
-  10 WATTS
-  MÁX. 850 LÚMENES
-  RGB CW MULTICOLOR Y BLANCOS ATENUABLES
-  110-130V~ 50/60Hz ENTRADA
-  E26 BASE
-  PROTECCIÓN IP20 INTERIOR
-  SI ATENUABLE
-  60x119 mm DIMENSIONES
-  OMNIDIRECCIONAL
-  180°
-  PLÁSTICO MATERIAL

## ALA-030

LÁMPARA LED SMART WIFI Y BLUETOOTH  
GU10 6W RGB CW MULTICOLOR Y BLANCOS ATENUABLES

-  SPOT
-  6 WATTS
-  MÁX. 400 LÚMENES
-  RGB CW MULTICOLOR Y BLANCOS ATENUABLES
-  110-130V~ 50/60Hz ENTRADA
-  GU10 BASE
-  PROTECCIÓN IP20 INTERIOR
-  SI ATENUABLE
-  50x55 mm DIMENSIONES
-  DIRECCIONAL
-  105°
-  PLÁSTICO MATERIAL



\*APP disponible para sistemas IOS y ANDROID.

\*Requiere conexión a internet mediante red Wi-Fi 2.4 GHz.

\*Compatible con comando de voz: Google Assistant y Amazon Alexa.

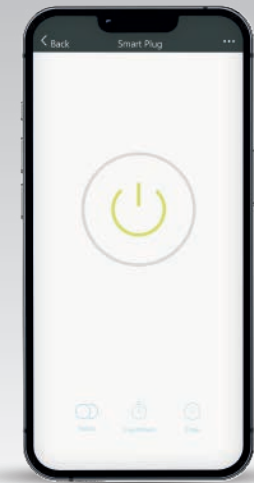

## ASM-001

\*Incluye 1 controlador y 1 driver.

TIRA LED SMART RGB CW COLORES Y  
BLANCOS DINAMICOS WIFI BLUETOOTH C/DRIVER

## ASM-002

ENCHUFE SMART REDONDO  
BLANCO WIFI BLUETOOTH MÁX. 1875W

TIRA LED	24 WATTS	MÁX. 1,300 LÚMENES
RGB CW MULTICOLOR Y BLANCOS ATENUABLES	100-240V~ 50/60Hz ENTRADA	INCLUYE CONTROLADOR Y DRIVER
PROTECCIÓN IP65 EXTERIOR	SI ATENUABLE	5000 x 12mm DIMENSIONES
OMNIDIRECCIONAL	120°	CUBIERTA DE SILICÓN MATERIAL

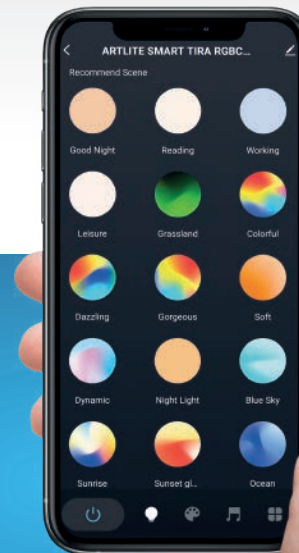

ENCHUFE	MÁX. 1875 WATTS	90-260V~ 50/60Hz ENTRADA
MÁXIMO 15A CORRIENTE @125V~	POLICARBONATO MATERIAL	50.6x52 mm DIMENSIONES
PROTECCIÓN IP20 INTERIOR		



7.3cm  
DIÁMETRO  
EMPOTRAMENTO

ADO-001

ADO-009

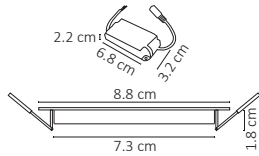

3W

10.3cm  
DIÁMETRO  
EMPOTRAMENTO

ADO-002

ADO-010

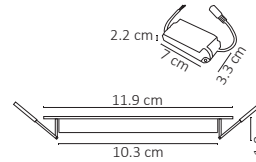

6W



ADO-015

ADO-016

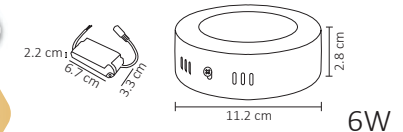

6W

15.5cm  
DIÁMETRO  
EMPOTRAMENTO

ADO-003

ADO-008

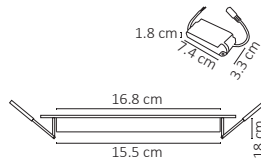

12W



ADO-004

ADO-012

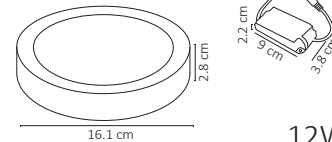

12W



ADO-018

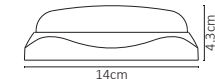

15W

#	💡	⚡	⚙️	360°	🌈	↔️	💎	🛡️	🔍	
Código	Producto	Watts	Voltaje	Lúmenes	Apertura	Temp. Color	Dimensiones	Material	Protección	Observaciones
ADO-001	Pánel LED Redondo Slim Blanco Frío	3W	90-277V~50/60Hz	250LM	120°	6500K	D. 88x18mm	Lámina + Policarbonato	IP20	Incluye Driver/Emp. 7.3cm
ADO-009	Pánel LED Redondo Slim Blanco Cálido	3W	90-277V~50/60Hz	230LM	120°	3000K	D. 88x18mm	Lámina + Policarbonato	IP20	Incluye Driver/Emp. 7.3cm
ADO-002	Pánel LED Redondo Slim Blanco Frío	6W	90-277V~50/60Hz	500LM	120°	6500K	D. 119x18mm	Lámina + Policarbonato	IP20	Incluye Driver/Emp. 10.3cm
ADO-010	Pánel LED Redondo Slim Blanco Cálido	6W	90-277V~50/60Hz	450LM	120°	3000K	D. 119x18mm	Lámina + Policarbonato	IP20	Incluye Driver/Emp. 10.3cm
ADO-015	Pánel LED Redondo Sobreponer Blanco Frío	6W	90-277V~50/60Hz	500LM	120°	6500K	D. 112x28mm	Lámina + Policarbonato	IP20	Incluye Driver
ADO-016	Pánel LED Redondo Sobreponer Blanco Cálido	6W	90-277V~50/60Hz	450LM	120°	3000K	D. 112x28mm	Lámina + Policarbonato	IP20	Incluye Driver
ADO-003	Pánel LED Redondo Slim Blanco Frío	12W	90-277V~50/60Hz	1,000LM	120°	6500K	D. 168x18mm	Lámina + Policarbonato	IP20	Incluye Driver/Emp. 15.5cm
ADO-008	Pánel LED Redondo Slim Blanco Cálido	12W	90-277V~50/60Hz	950LM	120°	3000K	D. 168x18mm	Lámina + Policarbonato	IP20	Incluye Driver/Emp. 15.5cm
ADO-004	Pánel LED Redondo Sobreponer Blanco Frío	12W	90-277V~50/60Hz	1,000LM	120°	6500K	D. 161x28mm	Lámina + Policarbonato	IP20	Incluye Driver
ADO-012	Pánel LED Redondo Sobreponer Blanco Cálido	12W	90-277V~50/60Hz	950LM	120°	3000K	D. 161x28mm	Lámina + Policarbonato	IP20	Incluye Driver
ADO-018	Pánel LED Redondo Sobreponer Blanco Frío	15W	100-277V~50/60Hz	1,400LM	120°	6500K	D. 140x43mm	Plástico + Policarbonato	IP65	Incluye Driver/A Prueba de Vapor





20.5 cm  
DIÁMETRO  
EMPOTRAMIENTO

ADO-005

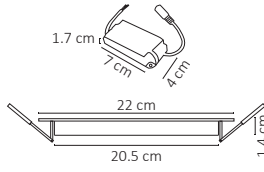

18W



ADO-013

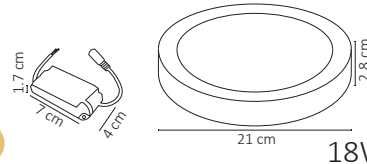

18W



ADO-019

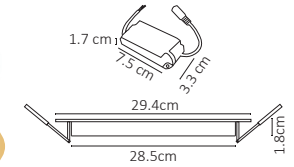

24W

28 cm  
DIÁMETRO  
EMPOTRAMIENTO

ADO-011

ADO-014

ADO-020



ADO-017

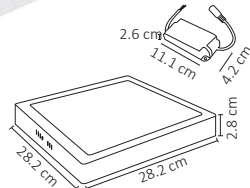

24W

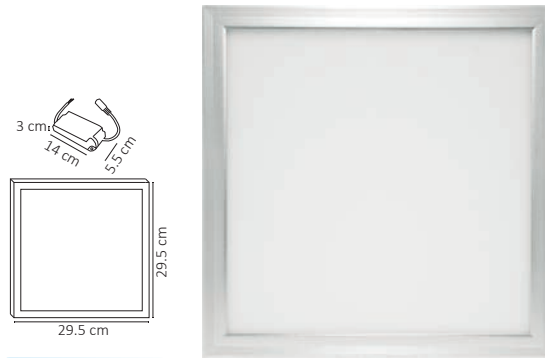

ADO-006

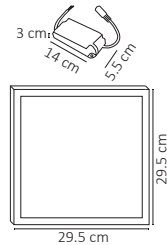

25W

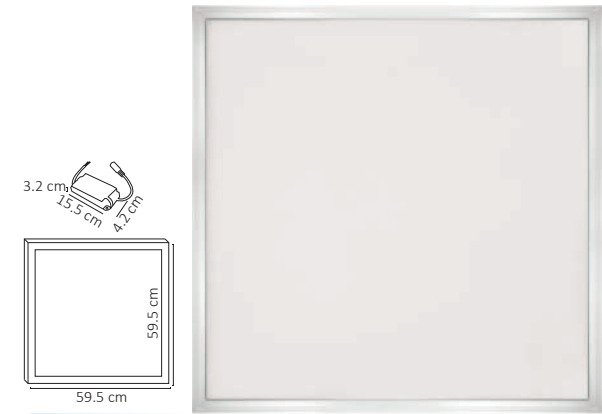

ADO-007

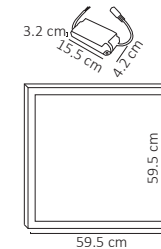

40W



Código	Producto	Watts	Voltaje	Lúmenes	Apertura	Temp. Color	Dimensiones	Material	Protección	Observaciones
ADO-005	Pánel LED Redondo Slim Blanco Frío	18W	90-277V~50/60Hz	1,500LM	120°	6500K	D. 220x14mm	Lámina + Policarbonato	IP20	Incluye Driver/Emp. 20.5cm
ADO-011	Pánel LED Redondo Slim Blanco Cálido	18W	90-277V~50/60Hz	1,450LM	120°	3000K	D. 220x14mm	Lámina + Policarbonato	IP20	Incluye Driver/Emp. 20.5cm
ADO-013	Pánel LED Redondo Blanco Frío	18W	90-277V~50/60Hz	1,500LM	120°	6500K	D. 210x28mm	Lámina + Policarbonato	IP20	Incluye Driver
ADO-014	Pánel LED Redondo Blanco Cálido	18W	90-277V~50/60Hz	1,450LM	120°	3000K	D. 210x28mm	Lámina + Policarbonato	IP20	Incluye Driver
ADO-019	Pánel LED Redondo Slim Blanco Frío	24W	90-277V~50/60Hz	2,000LM	120°	6500K	D. 294x18mm	Lámina + Policarbonato	IP20	Incluye Driver/Emp. 28.5cm
ADO-020	Pánel LED Redondo Slim Blanco Cálido	24W	90-277V~50/60Hz	1,950LM	120°	3000K	D. 294x18mm	Lámina + Policarbonato	IP20	Incluye Driver/Emp. 28.5cm
ADO-017	Pánel LED Cuadrado Sobreponer Blanco Frío	24W	90-277V~50/60Hz	1,800LM	120°	6500K	282x282x28mm	Lámina + Policarbonato	IP20	Incluye Driver
ADO-006	Pánel LED Cuadrado Slim Blanco Frío 30cm	25W	90-277V~50/60Hz	2,000LM	120°	6500K	295x295x25mm	Aluminio + Policarbonato	IP20	Incluye Driver y Sujetadores
ADO-007	Pánel LED Cuadrado Slim Blanco Frío 60cm	40W	90-277V~50/60Hz	3,400LM	120°	6500K	595x595x25mm	Aluminio + Policarbonato	IP20	Incluye Driver y Sujetadores

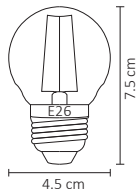

ALA-023



2W

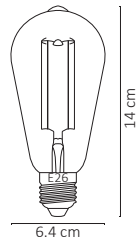

ALA-022



4W

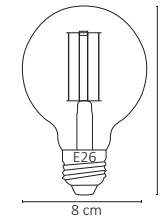

ALA-028



7W



#	💡	W	⚡	⚙️	360°	🌞	📏	💎	🛡️	🔍
Código	Producto	Watts	Voltaje	Lúmenes	Apertura	Temp. Color	Dimensiones	Material	Protección	Observaciones
ALA-023	Lámpara LED Filamento E26 2W G45 Ambar	2W	100-140V~50/60Hz	180LM	320°	1800K	D. 45x75mm	Lámina + Vidrio	IP20	E26
ALA-022	Lámpara LED Filamento E26 4W ST64 Ambar	4W	100-140V~50/60Hz	360LM	320°	1800K	64x140mm	Lámina + Vidrio	IP20	E26 - Dimeable
ALA-028	Lámpara LED de Filamento E26 7W Ambar	7W	100-140V~50/60Hz	700LM	320°	1800K	80x120mm	Lámina + Vidrio	IP20	E26 - Dimeable

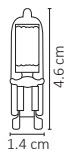

ALA-026



2W

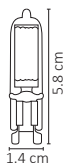

ALA-027



4W

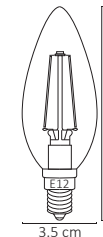

ALA-005



4W

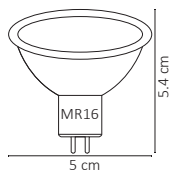

ALA-001



5W

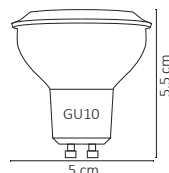

ALA-006



7W

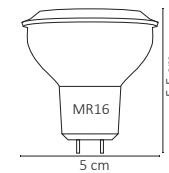

ALA-014



7W

ALA-002

ALA-007

ALA-015

#	💡	W	⚡	⚙️	360°	💡	📏	💎	🛡️	🔍
Código	Producto	Watts	Voltaje	Lúmenes	Apertura	Temp. Color	Dimensiones	Material	Protección	Observaciones
ALA-026	Lámpara LED G9 2W Ambar	2W	100-140V~50/60Hz	150LM	320°	1800K	14x50mm	Vidrio	IP20	G9
ALA-027	Lámpara LED G9 4W Ambar	4W	100-140V~50/60Hz	300LM	320°	1800K	15x60mm	Vidrio	IP20	G9
ALA-005	Lámpara Vela E12 Filamento Blanco Cálido	4W	100-140V~50/60Hz	400LM	320°	3000K	35x98mm	Lámina + Vidrio	IP20	E12 - Dimeable
ALA-001	Lámpara LED Spot MR-16 Blanco Frío	5W	100-140V~50/60Hz	430LM	45°	6500K	50x54mm	Cerámica + Vidrio	IP20	MR-16
ALA-002	Lámpara LED Spot MR-16 Blanco Cálido	5W	90-260V~50/60Hz	400LM	45°	3000K	50x54mm	Cerámica + Vidrio	IP20	MR-16
ALA-006	Lámpara LED Spot GU10 Blanco Frío	7W	90-260V~50/60Hz	580LM	45°	6500K	50x55mm	Plástico + Policarbonato	IP20	GU10
ALA-007	Lámpara LED Spot GU10 Blanco Cálido	7W	90-260V~50/60Hz	550LM	45°	3000K	50x55mm	Plástico + Policarbonato	IP20	GU10
ALA-014	Lámpara LED Spot MR-16 Blanco Frío	7W	90-260V~50/60Hz	580LM	45°	6500K	50x55mm	Plástico + Policarbonato	IP20	MR-16
ALA-015	Lámpara LED Spot MR-16 Blanco Cálido	7W	90-260V~50/60Hz	550LM	45°	3000K	50x55mm	Plástico + Policarbonato	IP20	MR-16



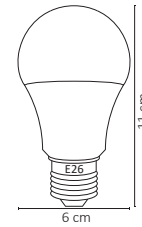

ALA-017

ALA-018



12W

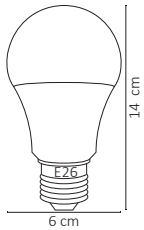

ALA-032

ALA-033



Próximamente

3 PACK

18W



#	💡	Ⓜ	⚡	⚙️	360°	🌞	📏	💎	🛡️	🔍
Código	Producto	Watts	Voltaje	Lúmenes	Apertura	Temp. Color	Dimensiones	Material	Protección	Observaciones
ALA-017	Lámpara LED Bulbo E26 Blanco Frío	12W	100-140V~50/60Hz	1,200LM	220°	6500K	60x110mm	Plástico + Policarbonato	IP20	Base E26
ALA-018	Lámpara LED Bulbo E26 Blanco Cálido	12W	100-140V~50/60Hz	1,100LM	220°	3000K	60x110mm	Plástico + Policarbonato	IP20	Base E26
ALA-032	Lámpara LED Bulbo E26 Blanco Frío	18W	100-140V~50/60Hz	1,200LM	220°	6500K	60x110mm	Plástico + Policarbonato	IP20	Incluye 3 Lámparas
ALA-033	Lámpara LED Bulbo E26 Blanco Cálido	18W	100-140V~50/60Hz	1,100LM	220°	3000K	60x110mm	Plástico + Policarbonato	IP20	Incluye 3 Lámparas

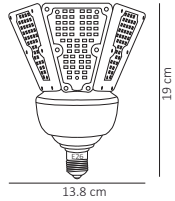

ALA-024

ALA-025



50W

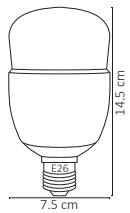

ALA-019



30W

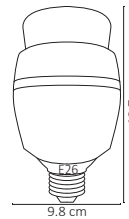

ALA-016



100W

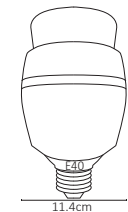

ALA-020



150W

#	💡	W	⚡	⚙️	360°	📏	💎	🛡️	🔍	
Código	Producto	Watts	Voltaje	Lúmenes	Apertura	Temp. Color	Dimensiones	Material	Protección	Observaciones
ALA-024	Lámpara LED Arbotante Punta Poste BC	50W	90-300V~50/60Hz	6,000LM	120°	3000K	138x190mm	PC + Alum. + Plástico	IP65	Base E26
ALA-025	Lámpara LED Arbotante Punta Poste BF	50W	90-300V~50/60Hz	6,500LM	120°	6500K	138x190mm	PC + Alum. + Plástico	IP65	Base E26
ALA-019	Lámpara LED Industrial E26 Blanco Frío	100W	90-300V~50/60Hz	10,000LM	120°	6500K	98x187mm	PC + Alum. + Plástico	IP20	Base E26
ALA-016	Lámpara LED Industrial E26 Blanco Frío	100W	90-300V~50/60Hz	10,000LM	120°	6500K	98x187mm	PC + Alum. + Plástico	IP20	E26/Ventilador Disipa Calor
ALA-020	Lámpara LED Industrial E40 Blanco Frío	150W	90-300V~50/60Hz	15,000LM	120°	6500K	115x230mm	PC + Alum. + Plástico	IP20	E40/Ventilador Disipa Calor



ATU-001

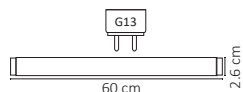

10W



ATU-010

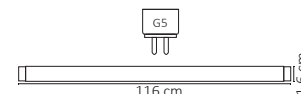

T5

18W



ATU-002

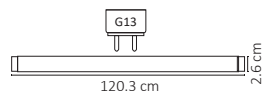

18W



ATU-004

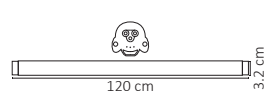

18W



ATU-007



36W



ATU-003



ATU-005



ATU-008

#	💡	W	⚡	💡	360°	☀️	↔️	💎	🛡️	🔍
Código	Producto	Watts	Voltaje	Lúmenes	Apertura	Temp. Color	Dimensiones	Material	Protección	Observaciones
ATU-001	Tubo LED T8 Opalino Blanco Frío	10W	90-260V~50/60Hz	950LM	150°	6500K	600x26mm	Plástico + Vidrio	IP20	Conexión 2 Polos
ATU-010	Tubo LED T5 Transparente	18W	100-265V~50/60Hz	2,000LM	150°	6500K	1160x16mm	Plástico + Vidrio	IP20	Conexión 2 Polos
ATU-002	Tubo LED T8 Transparente Blanco Frío	18W	90-260V~50/60Hz	2,000LM	120°	6500K	1203x26mm	Plástico + Vidrio	IP20	Conexión 2 Polos
ATU-003	Tubo LED T8 Opalino Blanco Frío	18W	90-260V~50/60Hz	1,900LM	150°	6500K	1203x26mm	Plástico + Vidrio	IP20	Conexión 2 Polos
ATU-004	Tubo LED T8 con Base Transparente Blanco Frío	18W	90-260V~50/60Hz	2,000LM	120°	6500K	1200x32mm	Plástico	IP20	Hasta 5 Interconexiones
ATU-005	Tubo LED T8 con Base Opalino Blanco Frío	18W	90-260V~50/60Hz	1,900LM	150°	6500K	1200x32mm	Plástico	IP20	Hasta 5 Interconexiones
ATU-007	Tubo LED T8 -1 PIN- Transparente Blanco Frío	36W	90-260V~50/60Hz	4,000LM	120°	6500K	2410x26mm	Plástico + Aluminio	IP20	Conexión 2 Polos
ATU-008	Tubo T8 -1 PIN- Opalino Blanco Frío	36W	90-260V~50/60Hz	3,800LM	150°	6500K	2410x26mm	Plástico + Aluminio	IP20	Conexión 2 Polos



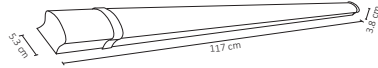

A Prueba de Vapor

40W

AGA-006

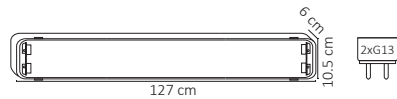

A Prueba de Vapor

2xG13

AGA-007

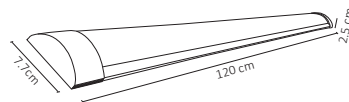

36W

AGA-008



#	💡	Ⓜ	⚡	⚙️	360°	🌞	📏	💎	🛡️	🔍
Código	Producto	Watts	Voltaje	Lúmenes	Apertura	Temp. Color	Dimensiones	Material	Protección	Observaciones
AGA-006	Gabinete Industrial LED Integrado a Prueba de Vapor IP65 Blanco Frío	40W	90-260V~50/60Hz	4,000LM	120°	6500K	1,170x53x60mm	Plástico	IP65	A Prueba de Vapor
AGA-007	Gabinete Industrial a Prueba de Vapor Slim para Dos Tubos T8	2x18W	90-260V~50/60Hz	-	120°	-	1,270x105x60mm	Policarbonato	IP65	No Incluye Tubos / 2xG13
AGA-008	Gabinete Slim Sobreponer LED Integrado Tipo Regleta Blanco Frío	36W	90-260V~50/60Hz	3,600LM	120°	6500K	1,200x77x25mm	Plástico	IP20	LED Intregado



ACO-010

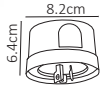

ACO-011

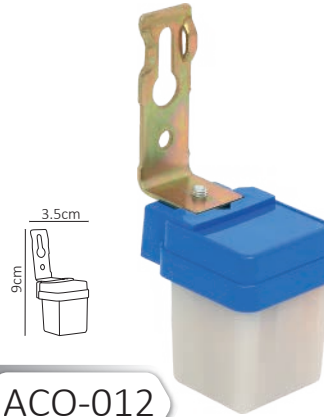
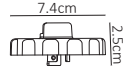

ACO-012



## Complementos

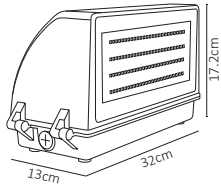

ARE-021



80W

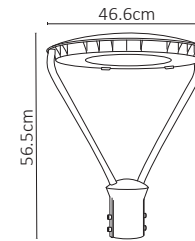

\*Incluye fotocelda

ARE-024

BASE  
FOTOCELDA  
NEMA  
3 pines

100W



Código	Producto	Watts	Voltaje	Lúmenes	Apertura	Temp. Color	Dimensiones	Material	Protección	Observaciones
ACO-010	Fotocelda Base NEMA de 3 Pines	1000W	120-270V~50/60Hz	-	-	-	D. 82x64mm	Plástico	IP44	1800 VA
ACO-011	Tapa para Base NEMA de 3 Pines	-	90-260V~50/60Hz	-	-	-	D. 74x25mm	Plástico	IP65	Fotocelda
ACO-012	Fotocelda Compacta 600W a Prueba de Lluvias	Máx. 600W	90-260V~50/60Hz	-	-	-	90x35x50mm	Plástico y Metal	IP44	Sensor Fotoselda / 6A
ARE-021	Luminaria WallPack para Pared	80W	90-277V~50/60Hz	10,000LM	80x105°	6500K	320x172x130mm	Aluminio + Vidrio	IP66	Para Calle
ARE-024	Luminaria 100W Punta Poste	100W	90-277V~50/60Hz	12,000LM	150°	5700K	D466x565mm	Aluminio + Vidrio	IP66	Base NEMA

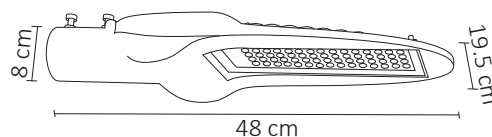

BASE PARA FOTOCELDA NEMA

ARE-019

60W

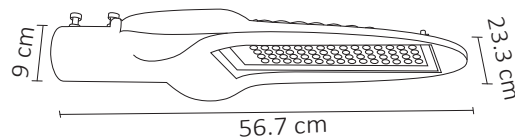

BASE PARA FOTOCELDA NEMA

ARE-020

100W

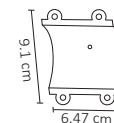

ACO-001

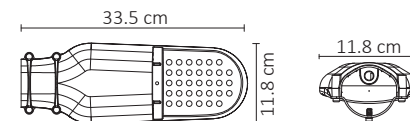

ARE-016

28W



Código	Producto	Watts	Voltaje	Lúmenes	Apertura	Temp. Color	Dimensiones	Material	Protección	Observaciones
ARE-019	Luminaria para Calle 60W Blanco Frío	60W	90-277V~50/60Hz	7,500LM	140°	5700K	480x195x80mm	Aluminio + Plástico	IP66	No incluye fotocelda
ARE-020	Luminaria para Calle 100W Blanco Frío	100W	90-277V~50/60Hz	12,500LM	150°	5700K	567x233x90mm	Aluminio + Plástico	IP66	No incluye fotocelda
ARE-016	Luminaria para Muro Blanco Frío	28W	100-260V~50/60Hz	2,500LM	120°	6500K	335x118x54.6mm	Aluminio + Plástico	IP65	Para Muro
ACO-001	Brazo Complemento para ARE-016	-	-	-	-	-	91x64.7x25mm	Metal	IP65	Complemento ARE-016



# Línea Solar



1,000  
LÚMENES





\*Potencia equivalente de una bombilla incandescente con un valor estimado de 10-12lm/W

## ASL-001

REFLECTOR LED SOLAR 1,000 LÚMENES  
CON PANEL EXTERNO Y CONTROL REMOTO

PANEL: Monocristalino 5V 15Wp MEDIDA PANEL: 350x350x17mm  
TIEMPO DE CARGA: 5-6 Horas DÍAS NUBLADOS: 3 Días

-  BATERÍA: 3.2V 10000mAh LiFePO4
-  WATTS \*Equivalencia: 100W
-  TEMP. COLOR.: 6500K Blanco Frío
-  LED: SMD2835 Lumiled
-  ATENUABLE: SI
-  MEDIDA: 192x132x41mm
-  APERTURA: 90°
-  MATERIAL: Aluminio Gris
-  IP65 Exterior

## ACO-008

CABLE 50CM PARA CARGAR  
LUMINARIA SOLAR

\*Solo funciona en ASL-002 y ASL-003





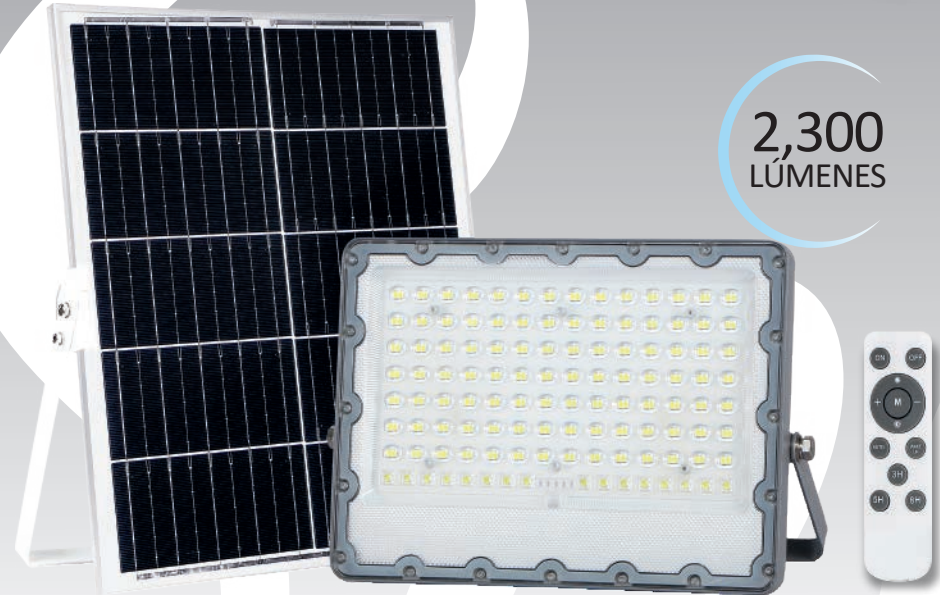



2,300  
LÚMENES



## ASL-002

REFLECTOR LED SOLAR 2,300 LÚMENES  
CON PANEL EXTERNO Y CONTROL REMOTO

PANEL: Monocristalino 5V 25Wp MEDIDA PANEL: 530x350x17mm  
TIEMPO DE CARGA: 5-6 Horas DÍAS NUBLADOS: 3 Días

-  BATERÍA: 3.2V 20000mAh LiFePO4
-  WATTS \*Equivalencia: 200W
-  TEMP. COLOR.: 6500K Blanco Frío
-  LED: SMD2835 Lumiled
-  ATENUABLE: SI
-  MEDIDA: 272x199x41mm
-  APERTURA: 90°
-  MATERIAL: Aluminio Gris
-  IP65 Exterior



EN CONDICIONES  
NORMALES\*

3,800  
LÚMENES



## ASL-003

LUMINARIA LED SOLAR 3,800 LÚMENES  
CON PANEL EXTERNO Y CONTROL REMOTO



\*Potencia equivalente de una bombilla incandescente con un valor estimado de 10-12lm/W  
\*Altura máxima recomendada 5m.  
\*Incluye accesorio de instalación y control remoto.

PANEL: Monocristalino 5V 40Wp MEDIDA PANEL: 670x350x25mm  
TIEMPO DE CARGA: 5-6 Horas DÍAS NUBLADOS: 3 Días

-  BATERÍA: 3.2V 40000mAh LiFePO4
-  WATTS \*Equivalencia: 300W
-  TEMP. COLOR.: 6500K Blanco Frío
-  LED: SMD2835 Lumiled
-  ATENUABLE: SI
-  MEDIDA: 532x240x69mm
-  APERTURA: 120° x 100°
-  MATERIAL: Aluminio Gris
-  IP65 Exterior

2,500  
LÚMENES











\*Potencia equivalente de una bombilla incandescente con un valor estimado de 10-12lm/W.  
\*Altura máxima recomendada 4m.  
\*Incluye accesorio de instalación y control remoto.  
\*Incluye solo una luminaria por caja.

## ASL-004

LUMINARIA LED SOLAR DE CALLE 2,500 LÚMENES  
ALL IN ONE CON PANEL SOLAR INTEGRADO



PANEL: Monocristalino 6V 30Wp MEDIDA PANEL: 655x260x4mm  
TIEMPO DE CARGA: 5-6 Horas DÍAS NUBLADOS: 3 Días

-  BATERÍA: 3.2V 30000mAh LiFePO4
-  WATTS \*Equivalencia: 200W
-  TEMP. COLOR.: 6500K Blanco Frío
-  LED: SMD2835 Lumiled
-  ATENUABLE: SI
-  MEDIDA: 752x266x45mm
-  APERTURA: 90° x 130°
-  MATERIAL: Aluminio Gris
-  IP65 Exterior



EN CONDICIONES  
NORMALES\*





1,300  
LÚMENES



\*Potencia equivalente de una bombilla incandescente con un valor estimado de 10-12lm/W

## ASL-005

LUMINARIA LED SOLAR DE CALLE 1,300 LÚMENES ALL IN ONE CON PANEL SOLAR INTEGRADO Y CONTROL REMOTO

PANEL: Monocristalino 6V 8Wp MEDIDA PANEL: 295x173mm  
TIEMPO DE CARGA: 5-6 Horas DÍAS NUBLADOS: 3 Días

- ⚡ BATERÍA: 3.7V 8000mAh, batería de litio.
- Ⓜ WATTS \*Equivalencia: 100W
- ☀ TEMP. COLOR.: 6500K Blanco Frío
- ⚙ LED: SMD2835
- 🔍 ATENUABLE: SI
- 📏 MEDIDA: 198x432x63mm
- 🌀 APERTURA: 90°
- 💎 MATERIAL: Plástico ABS Negro
- 🛡 IP65 Exterior



500  
LÚMENES



## ASL-006

REFLECTOR LED SOLAR 500 LÚMENES CON PANEL EXTERNO Y CONTROL REMOTO

PANEL: Monocristalino 6V 6Wp MEDIDA PANEL: 210x200x17mm  
TIEMPO DE CARGA: 5-6 Horas DÍAS NUBLADOS: 3 Días

- ⚡ BATERÍA: 3.2V 5000mAh LiFePO4
- Ⓜ WATTS \*Equivalencia: 50W
- ☀ TEMP. COLOR.: 6500K Blanco Frío
- ⚙ LED: SMD5050
- 🔍 ATENUABLE: SI
- 📏 MEDIDA: 222x185x44mm
- 🌀 APERTURA: 90°
- 💎 MATERIAL: Plástico ABS Negro
- 🛡 IP65 Exterior



EN CONDICIONES  
NORMALES\*





**Proyectos Solares**

12-24V

15.4 cm  
17 cm

**ARE-013** 30W

**Proyectos Solares**

12-24V

18.3 cm  
20.5 cm

**ARE-014** 50W

**110 LM/W EFICIENCIA**

12.1 cm  
13.1 cm

**ARE-001**

**ARE-002** 20W

**110 LM/W EFICIENCIA**

15.4 cm  
17 cm

**ARE-003**

**ARE-004** 30W

**110 LM/W EFICIENCIA**

18.3 cm  
20.5 cm

**ARE-005**

**ARE-006** 50W

#	💡	⚡	⚙️	360°	🌞	📏	💎	🛡️	🔍	
Código	Producto	Watts	Voltaje	Lúmenes	Apertura	Temp. Color	Dimensiones	Material	Protección	Observaciones
ARE-013	Reflector LED SMD Cuadrado Slim Blanco Frío	30W	12-24V==	3,300LM	120°	6500K	180x220x45mm	Aluminio + Vidrio	IP66	Para Proyectos Solares
ARE-014	Reflector LED SMD Cuadrado Slim Blanco Frío	50W	12-24V==	5,500LM	120°	6500K	220x280x50mm	Aluminio + Vidrio	IP66	Para Proyectos Solares
ARE-001	Reflector LED SMD Cuadrado Slim Blanco Frío	20W	90-277V~50/60Hz	2,200LM	120°	6500K	121x131x23mm	Aluminio + Vidrio	IP66	Fácil Instalación
ARE-002	Reflector LED SMD Cuadrado Slim Blanco Cálido	20W	90-277V~50/60Hz	2,100LM	120°	3000K	121x131x23mm	Aluminio + Vidrio	IP66	Fácil Instalación
ARE-003	Reflector LED SMD Cuadrado Slim Blanco Frío	30W	90-277V~50/60Hz	3,300LM	120°	6500K	154x170x31mm	Aluminio + Vidrio	IP66	Fácil Instalación
ARE-004	Reflector LED SMD Cuadrado Slim Blanco Cálido	30W	90-277V~50/60Hz	3,150LM	120°	3000K	154x170x31mm	Aluminio + Vidrio	IP66	Fácil Instalación
ARE-005	Reflector LED SMD Cuadrado Slim Blanco Frío	50W	90-277V~50/60Hz	5,500LM	120°	6500K	183x205x32mm	Aluminio + Vidrio	IP66	Fácil Instalación
ARE-006	Reflector LED SMD Cuadrado Slim Blanco Cálido	50W	90-277V~50/60Hz	5,250LM	120°	3000K	183x205x32mm	Aluminio + Vidrio	IP66	Fácil Instalación

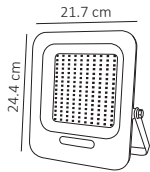
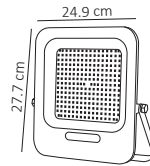
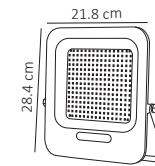
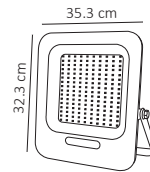
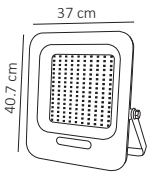
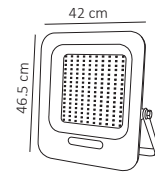
**110**  
 LM/W  
 EFICIENCIA

**ARE-007**
**100W**
**110**  
 LM/W  
 EFICIENCIA

**ARE-011**
**150W**
**110**  
 LM/W  
 EFICIENCIA

**ARE-017**
**200W**
**ALTA POTENCIA**
**125**  
 LM/W  
 EFICIENCIA

**ARE-025**
**300W**
**ALTA POTENCIA**
**125**  
 LM/W  
 EFICIENCIA

**ARE-026**
**400W**
**ALTA POTENCIA**
**125**  
 LM/W  
 EFICIENCIA

**ARE-027**
**500W**

#	💡	Ⓜ	⚡	⚙️	360°	⚙️	📏	💎	🛡️	🔍
Código	Producto	Watts	Voltaje	Lúmenes	Apertura	Temp. Color	Dimensiones	Material	Protección	Observaciones
ARE-007	Reflector LED SMD Cuadrado Slim Blanco Frío	100W	90-277V~50/60Hz	11,000LM	120°	6500K	217x244x33mm	Aluminio + Vidrio	IP66	Fácil Instalación
ARE-011	Reflector LED SMD Cuadrado Slim Blanco Frío	150W	90-277V~50/60Hz	16,500LM	120°	6500K	249x277x33mm	Aluminio + Vidrio	IP66	Fácil Instalación
ARE-017	Reflector LED SMD Cuadrado Slim Blanco Frío	200W	90-277V~50/60Hz	22,000LM	120°	6500K	284x218x33mm	Aluminio + Vidrio	IP66	Fácil Instalación
ARE-025	Reflector LED SMD Cuadrado Slim Blanco Frío	300W	90-277V~50/60Hz	37,500LM	120°	6500K	323x353x45mm	Aluminio + Vidrio	IP66	Fácil Instalación
ARE-026	Reflector LED SMD Cuadrado Slim Blanco Frío	400W	90-277V~50/60Hz	50,000LM	120°	6500K	407x370x45mm	Aluminio + Vidrio	IP66	Fácil Instalación
ARE-027	Reflector LED SMD Cuadrado Slim Blanco Frío	500W	90-277V~50/60Hz	62,500LM	120°	6500K	465x420x48mm	Aluminio + Vidrio	IP66	Fácil Instalación



**MAYOR CALIDAD Y POTENCIA**

**ALTA EFICIENCIA**

**130**  
LM/W  
EFICIENCIA

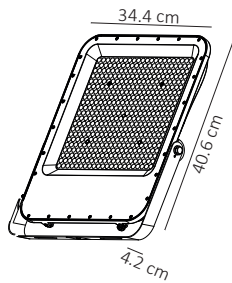

300W

ARE-018

**ALTA EFICIENCIA**

**130**  
LM/W  
EFICIENCIA

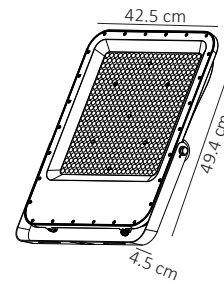

400W

ARE-022



Código	Producto	Watts	Voltaje	Lúmenes	Apertura	Temp. Color	Dimensiones	Material	Protección	Observaciones
ARE-018	Reflector LED SMD Profesional Slim Blanco Frío	300W	90-277V~50/60Hz	39,000LM	90°	6500K	344x406x42mm	Aluminio + PC	IP66	Fácil Instalación/con Óptica
ARE-022	Reflector LED SMD Profesional Slim Blanco Frío	400W	90-277V~50/60Hz	52,000LM	90°	6500K	425x494x45mm	Aluminio + PC	IP66	Fácil Instalación/con Óptica

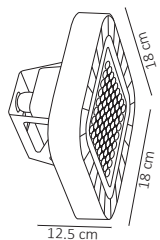

ARE-015

50W



ATENUABLE

160  
LM/W  
EFICIENCIA

ATENUABLE

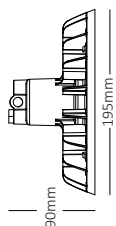
160  
LM/W  
EFICIENCIA160  
LM/W  
EFICIENCIA

ARE-028

70W

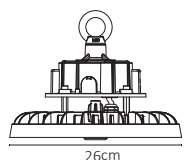

ARE-009

100W

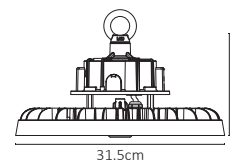

ARE-008

150W



Código	Producto	Watts	Voltaje	Lúmenes	Apertura	Temp. Color	Dimensiones	Material	Protección	Observaciones
ARE-015	Campana Modular LED Exterior	50W	90-260V~50/60Hz	5,000LM	90°	6500K	180x180x125mm	Aluminio + PC	IP66	Se Pueden Conectar en Gpo.
ARE-028	Campana Industrial Slim LED Blanco Frío	70W	90-300V~50/60Hz	11,200LM	120°	6500k	D.195x90mm	Aluminio + PC	IP66	Fácil Instalación
ARE-009	Campana Industrial Slim LED Exterior Blanco Frío	100W	100-305V~50/60Hz	16,000LM	120°	5700K	D. 260x150mm	Aluminio + PC	IP66	Atenuador Manual o Eléctrico
ARE-008	Campana Industrial Slim LED Exterior Blanco Frío	150W	100-305V~50/60Hz	24,000LM	90°	5700K	D. 315x155mm	Aluminio + PC	IP66	Atenuador Manual o Eléctrico





ATENUABLE

160  
LM/W  
EFICIENCIA



ARE-023

200W



ATENUABLE

160  
LM/W  
EFICIENCIA



ARE-012

240W



ACO-002

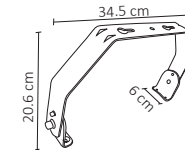

ACO-003



ACO-009

#	Light Bulb Icon	W	Lightning Bolt Icon	Gear Icon	360°	Light Bulb with Gear Icon	Double Arrow Icon	Diamond Icon	Shield Icon	Magnifying Glass Icon
Código	Producto	Watts	Voltaje	Lúmenes	Apertura	Temp. Color	Dimensiones	Material	Protección	Observaciones
ARE-023	Campana Industrial Slim LED Exterior Blanco Frío	200W	90-305V~50/60Hz	32,000LM	90°	5700K	D. 370x155mm	Aluminio + PC	IP66	Atenuador Manual o Eléctrico
ARE-012	Campana Industrial Slim LED Óptica Blanco Frío	240W	90-300V~50/60Hz	38,400LM	60°	5700K	D. 425x220mm	Aluminio + PC	IP66	Atenuador Manual o Eléctrico
ACO-002	Complemento para Fijar Campana Industrial 100W, 150W	-	-	-	-	-	114X125X32mm	Metal	-	Incluye 4 Tornillos Hexagonal 4mm de Punto Plana
ACO-003	Complemento para Fijar Campana Industrial 240W	-	-	-	-	-	206x345x60mm	Metal	-	Incluye 4 Tornillos Hexagonal 4mm de Punto Plana
ACO-009	Complemento para Fijar Campana Industrial 200W	-	-	-	-	-	152x180x40mm	Metal	-	Incluye 4 Tornillos Hexagonal 4mm de Punto Plana

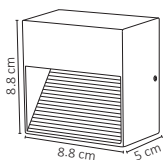

ADE-401

ADE-402

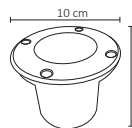

3W

9.4cm  
DIÁMETRO  
EMPOTRAMIENTO

ADE-201

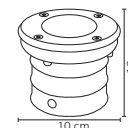

1xMR16

9.6cm  
DIÁMETRO  
EMPOTRAMIENTO

ADE-202



1xMR16

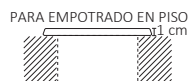
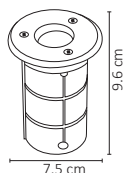

ADE-203

ADE-204

6cm  
DIÁMETRO  
EMPOTRAMIENTO

1W

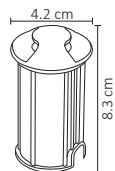

ADE-205

ADE-206

3.9cm  
DIÁMETRO  
EMPOTRAMIENTO

1W

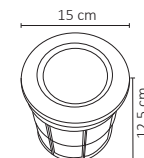

ADE-207

ADE-208

14.5cm  
DIÁMETRO  
EMPOTRAMIENTO

10W

#	💡	W	⚡	☀️	360°	🌈	↔️	💎	🛡️	🔍
Código	Producto	Watts	Voltaje	Lúmenes	Apertura	Temp. Color	Dimensiones	Material	Protección	Observaciones
ADE-401	Luminaria de Cortesía Blanco Frío	3W	90-260V~50/60Hz	80LM	90°	6500K	88x88x50mm	Aluminio + Plástico	IP54	Ideal para Escaleras, Pasillos, etc.
ADE-402	Luminaria de Cortesía Blanco Cálido	3W	90-260V~50/60Hz	75LM	90°	3000K	88x88x50mm	Aluminio + Plástico	IP54	Ideal para Escaleras, Pasillos, etc.
ADE-201	Luminaria de Piso Vidrio Templado	Máx. 50W	90-260V~50/60Hz	-	Máx. 90°	-	D. 100x60mm	Plástico + Vidrio Templ.	IP67	Emp./MR16/No Incluye Lámpara
ADE-202	Luminaria de Piso Satín y Vidrio Templado	Máx. 50W	90-260V~50/60Hz	-	Máx. 90°	-	D. 100x100mm	Plástico + Alum. + Vidrio	IP67	Emp./MR16/No Incluye Lámpara
ADE-203	Luminaria Piso LED Mini Integrado Blanco Frío	1W	90-260V~50/60Hz	80LM	60°	6500K	D. 75x96mm	Plástico + Alum. + Vidrio	IP67	Empotrable/Diam. Emp. 60mm
ADE-204	Luminaria Piso LED Mini Integrado Blanco Cálido	1W	90-260V~50/60Hz	75LM	60°	3000K	D. 75x96mm	Plástico + Alum. + Vidrio	IP67	Empotrable/Diam. Emp. 60mm
ADE-205	Luminaria de Piso Empotrable Blanco Frío	1W	90-260V~50/60Hz	80LM	60°/60°	6500K	D. 42x83mm	Aluminio + Plástico	IP67	Empotrable/Diam. Emp. 39mm
ADE-206	Luminaria de Piso Empotrable Blanco Cálido	1W	90-260V~50/60Hz	75LM	60°/60°	3000K	D. 42x83mm	Aluminio + Plástico	IP67	Empotrable/Diam. Emp. 39mm
ADE-207	Luminaria Piso LED Óptica Exterior Blanco Frío	10W	90-260V~50/60Hz	800LM	40°	6500K	D. 150x125mm	Plástico + Acero + Vidrio	IP67	Empotrable/Diam. Emp. 145mm
ADE-208	Luminaria Piso LED Óptica Exterior Blanco Cálido	10W	90-260V~50/60Hz	750LM	40°	3000K	D. 150x125mm	Plástico + Acero + Vidrio	IP67	Empotrable/Diam. Emp. 145mm



ACO-004



ADE-301

1xMR16

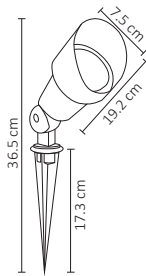

ADE-302



1xMR16



ADE-305

ADE-306

10W

Código	Producto	Watts	Voltaje	Lúmenes	Apertura	Temp. Color	Dimensiones	Material	Protección	Observaciones
ADE-301	Luminaria para Jardín con Base Sobreponer	Max. 50W	90-260V~50/60Hz	-	-	-	121x111x92mm	Plástico + Vidrio + Alum.	IP65	Sob./MR16/No Incluye Lámpara
ADE-302	Luminaria para Jardín Estaca	Máx. 50W	90-260V~50/60Hz	-	-	-	365x75mm	Aluminio + Vidrio	IP54	MR16/No Incluye Lámpara
ADE-305	Luminaria LED Jardín Estaca Negra Blanco Frío	10W	90-260V~50/60Hz	850LM	6500K	6500K	110x390x150mm	Aluminio + Vidrio	IP65	Estaca para Jardín
ADE-306	Luminaria LED Jardín Estaca Negra Blanco Cálido	10W	90-260V~50/60Hz	800LM	3000K	3000K	110x390x150mm	Aluminio + Vidrio	IP65	Estaca para Jardín
ACO-004	Complemento ADE-305 y ADE-306 para Sobreponer en Piso	-	-	-	-	-	140x50mm	Aluminio	IP65	Base Complemento

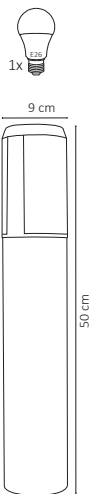
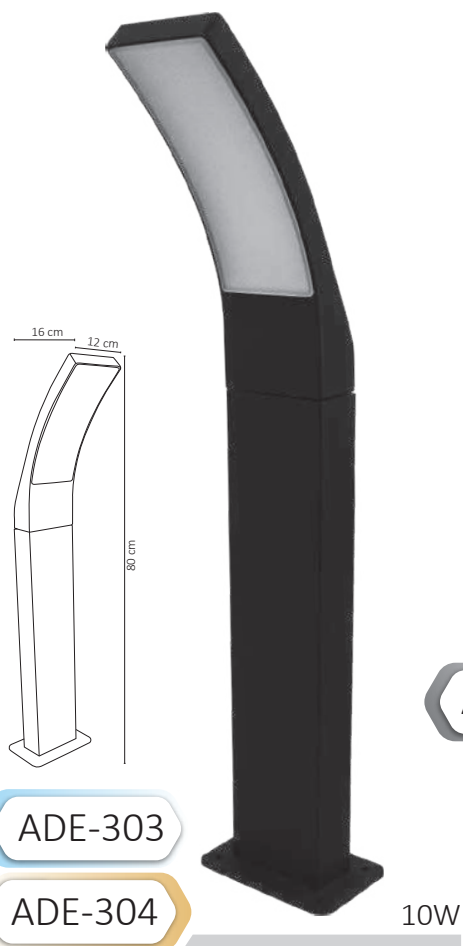

ADE-309

1xE26

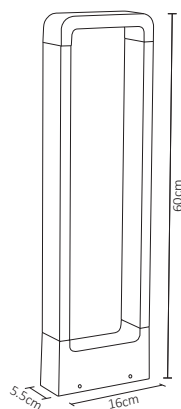

ADE-307

ADE-308

10W



Código	Producto	Watts	Voltaje	Lúmenes	Apertura	Temp. Color	Dimensiones	Material	Protección	Observaciones
ADE-303	Luminaria Tipo Mini Poste Exterior Blanco Frío	10W	90-260V~50/60Hz	900LM	90°	6500K	120x800x160mm	Aluminio + PC	IP54	Sobreponer en Piso
ADE-304	Luminaria Tipo Mini Poste Exterior Blanco Cálido	10W	90-260V~50/60Hz	850LM	90°	3000K	120x800x160mm	Aluminio + PC	IP54	Sobreponer en Piso
ADE-309	Luminaria Mini Poste Cilindro Sob. Aluminio Gris	Máx. 50W	90-260V~50/60Hz	-	Máx. 300°	-	90x500mm	Aluminio + PC	IP54	Sob./E26/Sin Lámpara
ADE-307	Luminaria LED Tubular Rectangular Blanco Frío	10W	90-260V~50/60Hz	900LM	120°/120°	6500K	160x600x55mm	Aluminio + Plástico	IP54	Sobreponer en Piso
ADE-308	Luminaria LED Tubular Rectangular Blanco Cálido	10W	90-260V~50/60Hz	850LM	120°/120°	3000K	160x600x55mm	Aluminio + Plástico	IP54	Sobreponer en Piso



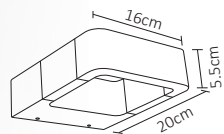

ADE-014

ADE-015



10W

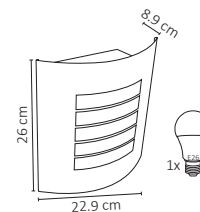

ADE-005

1xE26

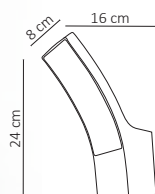

ADE-010

ADE-011



10W

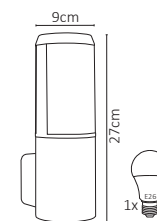

ADE-016

1xE26



#	💡	W	⚡	⚙️	360°	🌞	↔️	💎	🛡️	🔍
Código	Producto	Watts	Voltaje	Lúmenes	Apertura	Temp. Color	Dimensiones	Material	Protección	Observaciones
ADE-014	Luminaria LED de Pared Tubular Aluminio Negro Exterior Blanco Frío	10W	90-260V~50/60Hz	850LM	120°/120°	6500K	200x160x55mm	Aluminio + Plástico	IP54	Sobreponer/Doble Disparo
ADE-015	Luminaria LED de Pared Tubular Aluminio Negro Exterior Blanco Cálido	10W	90-260V~50/60Hz	800LM	120°/120°	3000K	200x160x55mm	Aluminio + Plástico	IP54	Sobreponer/Doble Disparo
ADE-005	Luminaria de Pared Pantalla con Rejilla	Máx. 50W	90-260V~50/60Hz	-	Máx. 120°	-	229x260x89mm	Acero Inox. + Plástico	IP54	Sob./E26/Sin Lámpara
ADE-010	Luminaria de Pared Exterior Blanco Frío	10W	90-260V~50/60Hz	850LM	90°	6500K	80x240x160mm	Aluminio + Plástico	IP54	Sobreponer en Pared
ADE-011	Luminaria de Pared Exterior Blanco Cálido	10W	90-260V~50/60Hz	800LM	90°	3000K	80x240x160mm	Aluminio + Plástico	IP54	Sobreponer en Pared
ADE-016	Luminaria Pared Cilíndrica Más PC Alum. Gris	Máx. 50W	90-260V~50/60Hz	-	Máx. 300°	-	90x270x130mm	Aluminio + PC	IP54	Sob./E26/Sin Lámpara

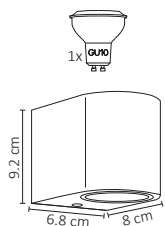

ADE-003

1xGU10

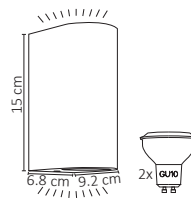

ADE-004

2xGU10

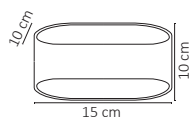

ADE-001

ADE-002

6W

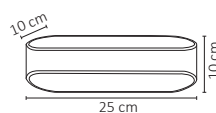

ADE-007

ADE-008

12W

#	Light Bulb	W	V	L	A	T	D	M	P	O
Código	Producto	Watts	Voltaje	Lúmenes	Apertura	Temp. Color	Dimensiones	Material	Protección	Observaciones
ADE-003	Luminaria de Pared Cilindro	Máx. 50W	90-260V~50/60Hz	-	Máx. 90°	-	68x80x92mm	Alum. + Vidrio + Plástico	IP54	Sob./GU10/Sin Lámpara
ADE-004	Luminaria de Pared Cilindro Doble	Máx. 50W	90-260V~50/60Hz	-	Máx. 90°	-	68x80x92mm	Alum. + Vidrio + Plástico	IP54	Sob./GU10/Sin Lámpara
ADE-001	Luminaria de Pared LED Exterior Blanco Frío	6W	90-260V~50/60Hz	500LM	45°/45°	6500K	150x100x100mm	Aluminio + Plástico	IP54	Sobreponer
ADE-002	Luminaria de Pared LED Exterior Blanco Cálido	6W	90-260V~50/60Hz	450LM	45°/45°	3000K	150x100x100mm	Aluminio + Plástico	IP54	Sobreponer
ADE-007	Luminaria de Pared LED Exterior Blanco Frío	12W	90-260V~50/60Hz	900LM	45°/45°	6500K	250x100x100mm	Aluminio + Plástico	IP54	Sobreponer
ADE-008	Luminaria de Pared LED Exterior Blanco Cálido	12W	90-260V~50/60Hz	850LM	45°/45°	3000K	250x100x100mm	Aluminio + Plástico	IP54	Sobreponer



ADE-006

2xGU10

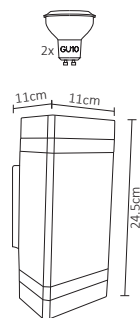

ADE-012

2xGU10

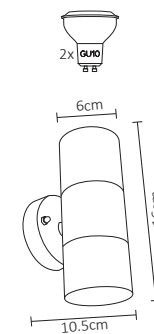

ADE-013

2xGU10

#	💡	Ⓜ	⚡	⚙️	⦿	🌈	📏	💎	🛡️	🔍
Código	Producto	Watts	Voltaje	Lúmenes	Apertura	Temp. Color	Dimensiones	Material	Protección	Observaciones
ADE-006	Luminaria Cilindro Doble Aro	Máx. 50W	90-260V~50/60Hz	-	Máx. 90°/90°	-	103x233x108mm	Alum. + Plástico + PC	IP54	Sob./2xGU10/Sin Lámpara
ADE-012	Luminaria de Pared Rectangular Doble Aluminio Negro Exterior Base GU10	Máx. 50W	90-260V~50/60Hz	-	Máx. 80°/80°	-	110x250x110mm	Alum. + Plástico + PC	IP54	Sob./2xGU10/Sin Lámpara
ADE-013	Luminaria de Pared Cilindro Doble Satín Exterior Base GU10	Máx. 50W	90-260V~50/60Hz	-	Máx. 80°/80°	-	60x160x105mm	Aluminio + Vidrio	IP54	Sob./2xGU10/Sin Lámpara

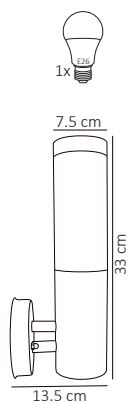

ADE-017

1xE26

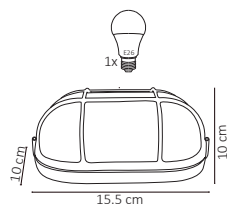

ADE-018

1xE26

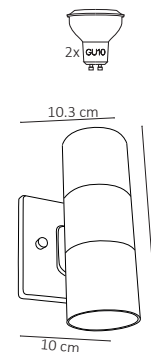

ADE-019

2xGU10



Código	Producto	Watts	Voltaje	Lúmenes	Apertura	Temp. Color	Dimensiones	Material	Protección	Observaciones
ADE-017	Lum. Pared Cilindro Vertical Cubierta Opalino	Máx. 50W	90-260V~50/60Hz	-	Máx. 80°/80°	-	75x330x135mm	PC + Acero Inoxidable	IP54	Sob./E26/Sin Lámpara
ADE-018	Lum. Pared Nautica Rejilla Negra Cub. Opalina	Máx. 50W	90-260V~50/60Hz	-	-	-	103x182x100mm	Aluminio + Vidrio	IP54	Sob./1xE26/Sin Lámpara
ADE-019	Luminaria Pared Cilindro Doble Negro Mate	Máx. 50W	90-260V~50/60Hz	-	Máx. 80°/80°	-	-	Aluminio + Vidrio Temp.	IP54	Sob./2xGU10/Sin Lámpara



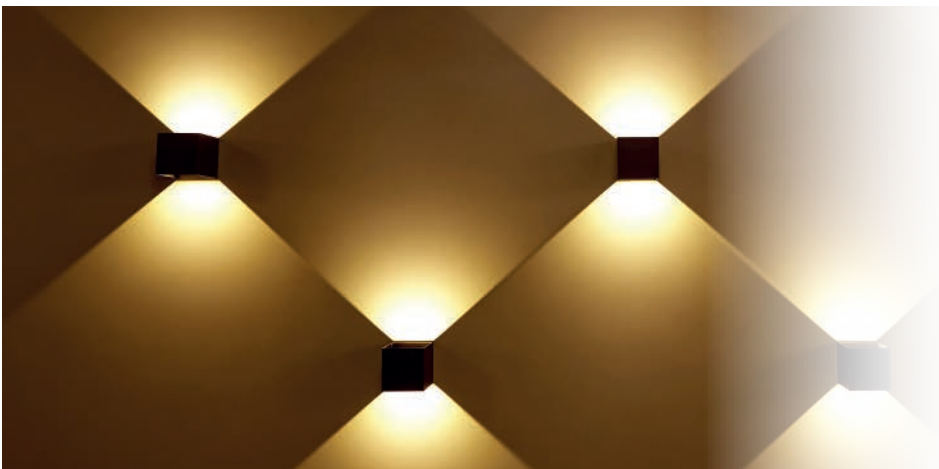

## Sensor de Luz

Enciende en ausencia de luz, se apaga automáticamente al recibir luz.

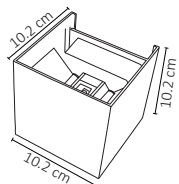

ADE-020

ADE-021

6W

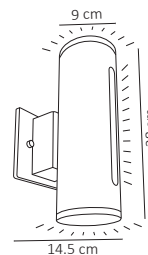

ADE-022

ADE-023

11W

#	💡	Ⓜ	⚡	⚙️	360°	☀️	↔️	💎	🛡️	🔍
Código	Producto	Watts	Voltaje	Lúmenes	Apertura	Temp. Color	Dimensiones	Material	Protección	Observaciones
ADE-020	Luminaria Led Pared Cubo Doble Disparo y Angulo Ajustable Blanco Frío Negro Mate	6W	90-260V~50/60Hz	360LM	2x45°	6500K	102x102mm	Aluminio	IP54	Fácil Instalación Ángulo Ajustable
ADE-021	Luminaria Led Pared Cubo Doble Disparo y Angulo Ajustable Blanco Cálido Negro Mate	6W	90-260V~50/60Hz	350LM	2x45°	3000K	102x102mm	Aluminio	IP54	Fácil Instalación Ángulo Ajustable
ADE-022	Luminaria Pared Cilindro Doble con Lineal Frontal Blanco Frío	11W	90-260V~50/60Hz	700LM	2x150°	6500K	114x280x145mm	Aluminio + PC	IP54	Sobreponer en Pared con sensor de luz
ADE-023	Luminaria Pared Cilindro Doble con Lineal Frontal Blanco Cálido	11W	90-260V~50/60Hz	650LM	2x150°	3000K	114x280x145mm	Aluminio + PC	IP54	Sobreponer en Pared con sensor de luz

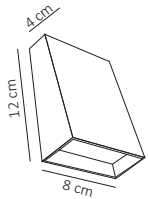

ADE-024

ADE-025



5W

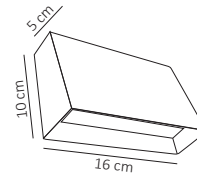

ADE-026

ADE-027



10W

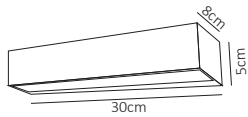

ADE-028

ADE-029



18W

#	💡	W	⚡	☀️	360°	⚙️	📏	💎	🛡️	🔍
Código	Producto	Watts	Voltaje	Lúmenes	Apertura	Temp. Color	Dimensiones	Material	Protección	Observaciones
ADE-024	Luminaria LED de Pared Prisma Disparo Sencillo Aluminio Negro Exterior Blanco Frío	5W	90-260V~50/60Hz	300LM	120°	6500K	120x80x40mm	Aluminio Negro	IP54	Disparo Sencillo Pared
ADE-025	Luminaria LED de Pared Prisma Disparo Sencillo Aluminio Negro Exterior Blanco Cálido	5W	90-260V~50/60Hz	280LM	120°	3000K	120x80x40mm	Aluminio Negro	IP54	Disparo Sencillo Pared
ADE-026	Luminaria LED de Pared Prisma Disparo Sencillo Aluminio Negro Exterior Blanco Frío	10W	90-260V~50/60Hz	600LM	120°	6500K	160x100x50mm	Aluminio Negro	IP54	Disparo Sencillo Pared
ADE-027	Luminaria LED de Pared Prisma Disparo Sencillo Aluminio Negro Exterior Blanco Cálido	10W	90-260V~50/60Hz	550LM	120°	3000K	160x100x50mm	Aluminio Negro	IP54	Disparo Sencillo Pared
ADE-028	Luminaria Pared Barra Lineal Negro Blanco Frío	18W	90-260V~50/60Hz	1250LM	120°	6500K	300x80x50mm	Aluminio + Vidrio	IP54	Disparo Sencillo Pared
ADE-029	Luminaria Pared Barra Lineal Negro Blanco Cálido	18W	90-260V~50/60Hz	1240LM	120°	3000K	300x80x50mm	Aluminio + Vidrio	IP54	Disparo Sencillo Pared

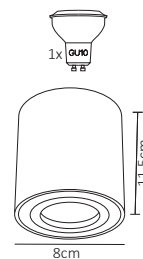

ADE-701

1xGU10



ADE-501

12 x E26

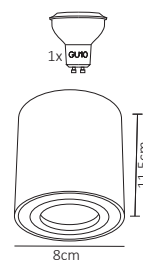

ADE-702

1xGU10

#	💡	W	⚡	⚙️	360°	☀️	↔️	💎	🛡️	🔍
Código	Producto	Watts	Voltaje	Lúmenes	Apertura	Temp. Color	Dimensiones	Material	Protección	Observaciones
ADE-501	Extensión de Sockets para 12 Bulbos	Máx. 50W	90-260V~50/60Hz	-	Máx. 320°	-	Extensión 7.5m	Plástico	IP65	12 bases E26/No incluye focos
ADE-701	Luminaria Sobreponer Techo Cilíndrico Dirigible Aluminio Blanco para GU10	Máx. 50W	90-260V~50/60Hz	-	Máx. 120°	-	D. 80x115mm	Aluminio	IP20	Sob./1xGU10/No incluye lámpara
ADE-702	Luminaria Sobreponer Techo Cilíndrico Dirigible Aluminio Negro para GU10	Máx. 50W	90-260V~50/60Hz	-	Máx. 120°	-	D. 80x115mm	Aluminio	IP20	Sob./1xGU10/No incluye lámpara



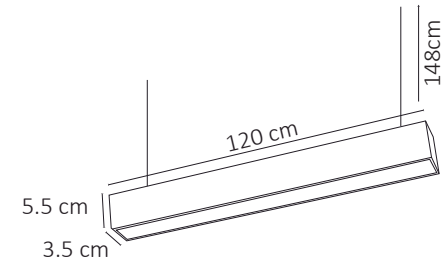

ADE-609

ADE-610

40W



Código	Producto	Watts	Voltaje	Lúmenes	Apertura	Temp. Color	Dimensiones	Material	Protección	Observaciones
ADE-609	Luminaria LED Colgante Negro Blanco Frío	40W	90-260V~50/60Hz	3,100LM	120°	6500K	1200x35x55mm	Aluminio + PC	IP20	Med. Cable: 148 cm
ADE-610	Luminaria LED Colgante Negro Blanco Cálido	40W	90-260V~50/60Hz	3,400LM	120°	3000K	1200x35x55mm	Aluminio + PC	IP20	Med. Cable: 148 cm

**Próximamente**



 **Con Óptica**

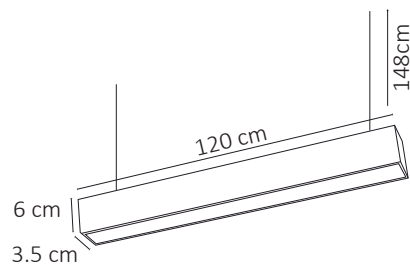

ADE-611

ADE-612

40W



 **Con Óptica**



Código	Producto	Watts	Voltaje	Lúmenes	Apertura	Temp. Color	Dimensiones	Material	Protección	Observaciones
ADE-611	Luminaria LED Colgante Negro Blanco Frío	40W	90-260V~50/60Hz	1,550LM	120°	6500K	1200x35x60mm	Alum. + Policarbonato	IP20	Med. Cable: 148 cm / Optica
ADE-612	Luminaria LED Colgante Negro Blanco Cálido	40W	90-260V~50/60Hz	1,500LM	120°	3000K	1200x35x60mm	Alum. + Policarbonato	IP20	Med. Cable: 148 cm / Optica

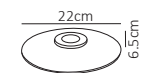
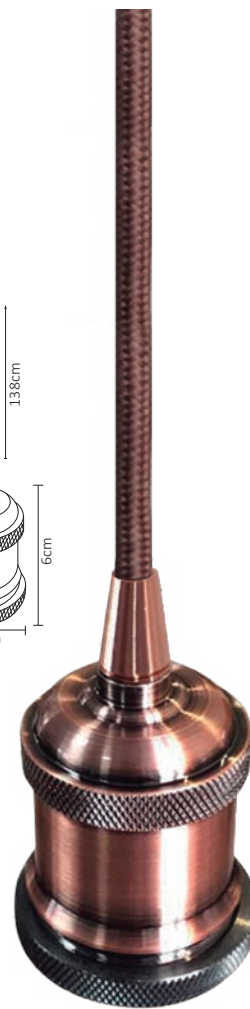
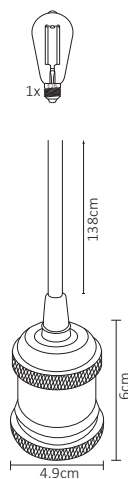
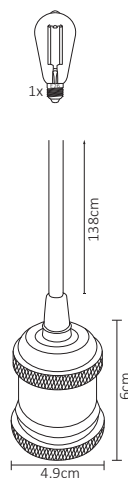
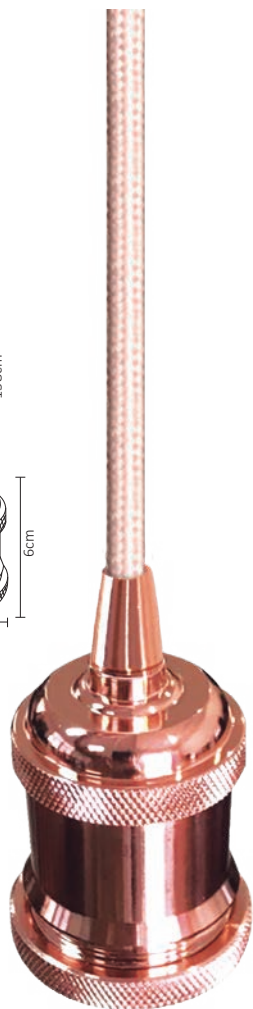
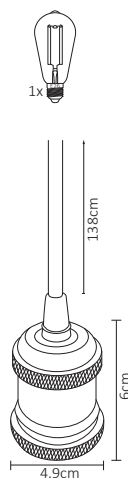

ACO-005

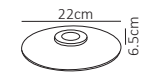

ACO-006

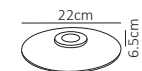

ACO-007

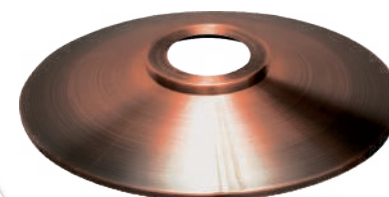

ADE-601

1xE26

ADE-602

1xE26

ADE-603

1xE26



Código	Producto	Watts	Voltaje	Lúmenes	Apertura	Temp. Color	Dimensiones	Material	Protección	Observaciones
ADE-601	Colgante Vintage Bulbo E26 Oro Rosado	Máx. 50W	90-260V~50/60Hz	-	Máx. 320°	-	D. 49x60mm	Aluminio + Nylon	IP20	No incluye lámpara E26 Medida del cable: 138cm
ADE-602	Colgante Vintage Bulbo E26 Negro Pulido	Máx. 50W	90-260V~50/60Hz	-	Máx. 320°	-	D. 49x60mm	Aluminio + Nylon	IP20	No incluye lámpara E26 Medida del cable: 138cm
ADE-603	Colgante Vintage Bulbo E26 Cobre Antiguo	Máx. 50W	90-260V~50/60Hz	-	Máx. 320°	-	D. 49x60mm	Aluminio + Nylon	IP20	No incluye lámpara E26 Medida del cable: 138cm
ACO-005	Complemento Redondo p/ADE-601 Oro Rosado	-	-	-	-	-	D. 220x65mm	Aluminio	IP20	No incluye colgante
ACO-006	Complemento Redondo p/ADE-602 Negro Pulido	-	-	-	-	-	D. 220x65mm	Aluminio	IP20	No incluye colgante
ACO-007	Complemento Redondo p/ADE-603 Cobre Antiguo	-	-	-	-	-	D. 220x65mm	Aluminio	IP20	No incluye colgante





ADE-604

1xE26

ADE-605

1xE26

ADE-606

1xE26

ADE-607

1xGU10

ADE-608

1xGU10

#	💡	Ⓜ	⚡	⚙	360°	🌈	↔	💎	🛡	🔍
Código	Producto	Watts	Voltaje	Lúmenes	Apertura	Temp. Color	Dimensiones	Material	Protección	Observaciones
ADE-604	Colgante Cilíndrico Bulbo E26 Oro Rosado	Max. 50W	90-260V~50/60Hz	-	Máx. 320°	-	D. 45x64mm	Aluminio + Nailon	IP20	No incluye lámpara E26 Medida del cable: 138cm
ADE-605	Colgante Cilíndrico Bulbo E26 Negro Pulido	Máx. 50W	90-260V~50/60Hz	-	Máx. 320°	-	D. 45x64mm	Aluminio + Nailon	IP20	No incluye lámpara E26 Medida del cable: 138cm
ADE-606	Colgante Cilíndrico Bulbo E26 Cobre Antiguo	Máx. 50W	90-260V~50/60Hz	-	Máx. 320°	-	D. 45x64mm	Aluminio + Nailon	IP20	No incluye lámpara E26 Medida del cable: 138cm
ADE-607	Colgante Cubierta Cilíndrica Aluminio Blanco	Máx. 50W	90-260V~50/60Hz	-	Máx. 120°	-	D. 170x55mm	Aluminio	IP20	No incluye lámpara GU10 Medida del cable: 80cm
ADE-608	Colgante Cubierta Cilíndrica Aluminio Negro	Máx. 50W	90-260V~50/60Hz	-	Máx. 120°	-	D. 170x55mm	Aluminio	IP20	No incluye lámpara GU10 Medida del cable: 80cm

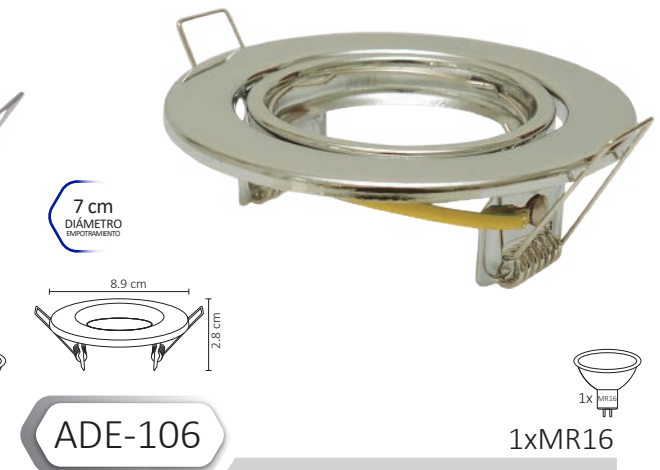
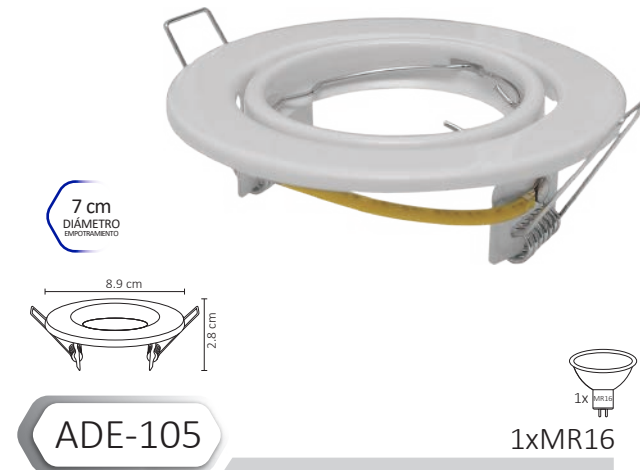
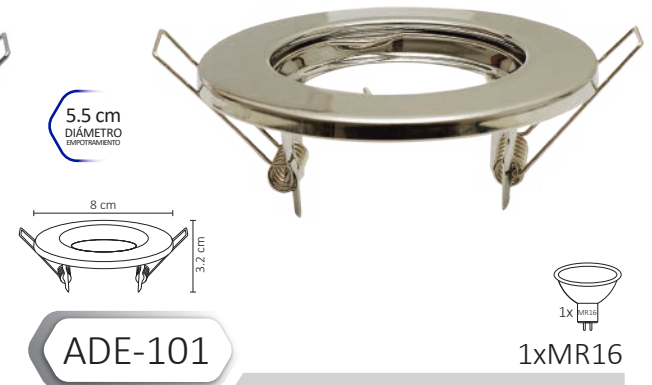
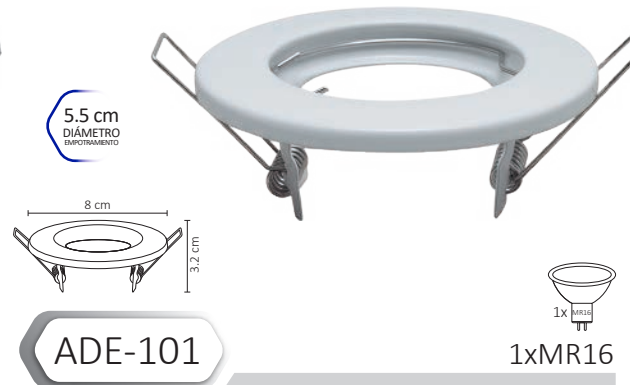

#	💡	W	⚡	360°	↔	💎	🛡️	🔍
Código	Producto	Watts	Voltaje	Apertura	Dimensiones	Material	Protección	Observaciones
ADE-101	Empotrable Fijo Aro Metálico Negro	Máx. 50W	90-260V~50/60Hz	Máx. 120°	D. 80x32mm	Metal	IP20	Base MR16 / No Incluye Lámpara / Emp. 55mm
ADE-102	Empotrable Fijo Aro Metálico Blanco	Máx. 50W	90-260V~50/60Hz	Máx. 120°	D. 80x32mm	Metal	IP20	Base MR16 / No Incluye Lámpara / Emp. 55mm
ADE-103	Empotrable Fijo Aro Metálico Satin	Máx. 50W	90-260V~50/60Hz	Máx. 120°	D. 80x32mm	Metal	IP20	Base MR16 / No Incluye Lámpara / Emp. 55mm
ADE-104	Empotrable Dirigible Aro Metálico Negro	Máx. 50W	90-260V~50/60Hz	Máx. 120°	D. 89x28mm	Metal	IP20	Base MR16 / No Incluye Lámpara / Emp. 70mm
ADE-105	Empotrable Dirigible Aro Metálico Blanco	Máx. 50W	90-260V~50/60Hz	Máx. 120°	D. 89x28mm	Metal	IP20	Base MR16 / No Incluye Lámpara / Emp. 70mm
ADE-106	Empotrable Dirigible Aro Metálico Satin	Máx. 50W	90-260V~50/60Hz	Máx. 120°	D. 89x28mm	Metal	IP20	Base MR16 / No Incluye Lámpara / Emp. 70mm



9x9cm  
MEDIDA  
EMPOTRAMIENTO

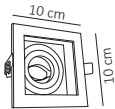

ADE-107

1xMR16



17.5x9cm  
MEDIDA  
EMPOTRAMIENTO

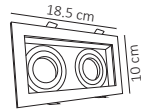

ADE-109

2xMR16



26x9cm  
MEDIDA  
EMPOTRAMIENTO

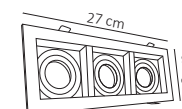

ADE-111

3xMR16



9x9cm  
MEDIDA  
EMPOTRAMIENTO

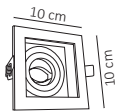

ADE-108

1xMR16



17.5x9cm  
MEDIDA  
EMPOTRAMIENTO



ADE-110

2xMR16

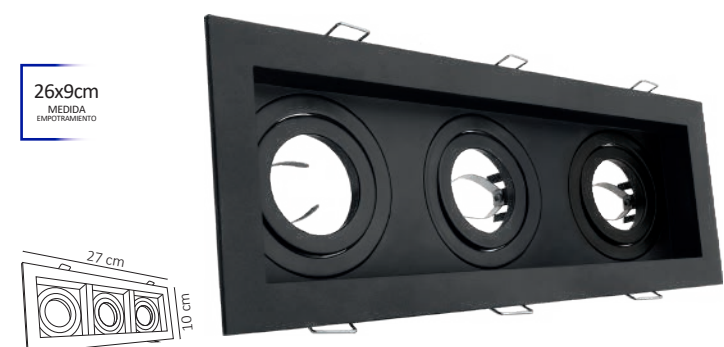

26x9cm  
MEDIDA  
EMPOTRAMIENTO

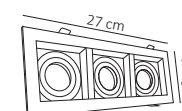

ADE-112

3xMR16

#	💡	W	⚡	360°	↔	💎	🛡️	🔍
Código	Producto	Watts	Voltaje	Apertura	Dimensiones	Material	Protección	Observaciones
ADE-107	Empotrable Dirigible para Spot Sencillo Blanco	Máx. 50W	90-260V~50/60Hz	Máx. 120°	100x100x40mm	Metal	IP20	1xMR16/No Incluye Lámpara/Emp. 90x90mm
ADE-108	Empotrable Dirigible para Spot Sencillo Negro	Máx. 50W	90-260V~50/60Hz	Máx. 120°	100x100x40mm	Metal	IP20	1xMR16/No Incluye Lámpara/Emp. 90x90mm
ADE-109	Empotrable Dirigible para Spot Doble Blanco	Máx. 50W	90-260V~50/60Hz	Máx. 120°	185x100x40mm	Metal	IP20	2xMR16/No Incluye Lámpara/Emp. 175x90mm
ADE-110	Empotrable Dirigible para Spot Doble Negro	Máx. 50W	90-260V~50/60Hz	Máx. 120°	185x100x40mm	Metal	IP20	2xMR16/No Incluye Lámpara/Emp. 175x90mm
ADE-111	Empotrable Dirigible para Spot Triple Blanco	Máx. 50W	90-260V~50/60Hz	Máx. 120°	270x100x40mm	Metal	IP20	3xMR16/No Incluye Lámpara/Emp. 260x90mm
ADE-112	Empotrable Dirigible para Spot Triple Negro	Máx. 50W	90-260V~50/60Hz	Máx. 120°	270x100x40mm	Metal	IP20	3xMR16/No Incluye Lámpara/Emp. 260x90mm





WDE-001

WDE-002

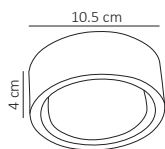

6W

WDE-003

WDE-004

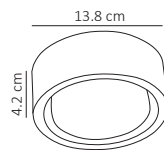

12W

WDE-005

WDE-006

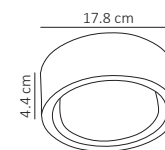

18W



Código	Producto	Watts	Voltaje	Lúmenes	Apertura	Temp. Color	Dimensiones	Material	Protección	Observaciones
WDE-001	Luminaria Sobreponer Techo Circular Metal Negro BF	6W	90-260V~50/60Hz	360LM	120°	6500K	D. 105x40mm	Metal + PC	IP20	Sobreponer / Fácil Instalación
WDE-002	Luminaria Sobreponer Techo Circular Metal Negro BC	6W	90-260V~50/60Hz	360LM	120°	3000K	D. 105x40mm	Metal + PC	IP20	Sobreponer / Fácil Instalación
WDE-003	Luminaria Sobreponer Techo Circular Metal Negro BF	12W	90-260V~50/60Hz	900LM	120°	6500K	D. 138x42mm	Metal + PC	IP20	Sobreponer / Fácil Instalación
WDE-004	Luminaria Sobreponer Techo Circular Metal Negro BC	12W	90-260V~50/60Hz	900LM	120°	3000K	D. 138x42mm	Metal + PC	IP20	Sobreponer / Fácil Instalación
WDE-005	Luminaria Sobreponer Techo Circular Metal Negro BF	18W	90-260V~50/60Hz	1,440LM	120°	6500K	D. 178x44mm	Metal + PC	IP20	Sobreponer / Fácil Instalación
WDE-006	Luminaria Sobreponer Techo Circular Metal Negro BC	18W	90-260V~50/60Hz	1,440LM	120°	3000K	D. 178x44mm	Metal + PC	IP20	Sobreponer / Fácil Instalación



WDE-007

WDE-008

12W

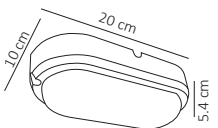

WDE-009

WDE-010

18W

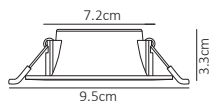

#	💡	Ⓜ	⚡	⚙️	360°	🌞	📏	💎	🛡️	🔍
Código	Producto	Watts	Voltaje	Lúmenes	Apertura	Temp. Color	Dimensiones	Material	Prot	Observaciones
WDE-007	Luminaria LED Pared Nautica Blanco PC Blanco Frío	12W	90-260V~50/60Hz	850LM	120°	6500K	177x85x55mm	Plástico	IP20	Fácil Instalación
WDE-008	Luminaria LED Pared Nautica Blanco PC Blanco Cálido	12W	90-260V~50/60Hz	840LM	120°	3000K	177x85x55mm	Plástico	IP20	Fácil Instalación
WDE-009	Luminaria LED Pared Nautica Blanco PC Blanco Frío	18W	90-260V~50/60Hz	1260LM	120°	6500K	200x100x54mm	Plástico	IP20	Fácil Instalación
WDE-010	Luminaria LED Pared Nautica Blanco PC Blanco Cálido	18W	90-260V~50/60Hz	1250LM	120°	3000K	200x100x54mm	Plastico	IP20	Fácil Instalación

8.5 cm  
 DIÁMETRO  
 EMPOTRAMIENTO

WDO-002

WDO-005

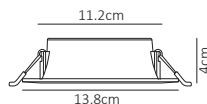

5W

 12 cm  
 DIÁMETRO  
 EMPOTRAMIENTO

WDO-003

WDO-006



12W

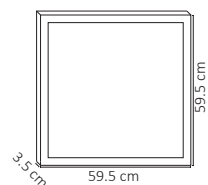

WDO-001

36W

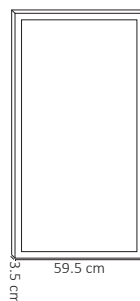
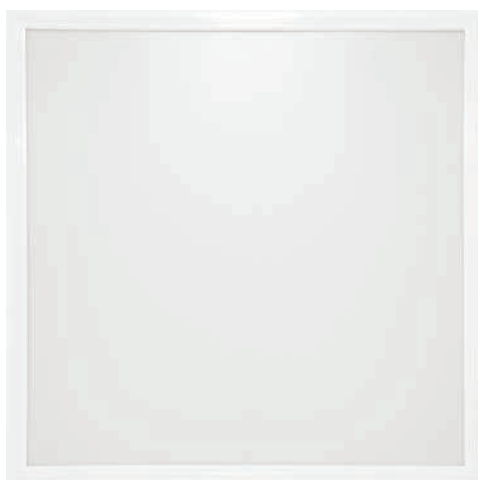

WDO-004

72W



Código	Producto	Watts	Voltaje	Lúmenes	Apertura	Temp. Color	Dimensiones	Material	Protección	Observaciones
WDO-002	Pánel LED Redondo 5W Blanco Frío	5W	90-260V~50/60Hz	380LM	120°	6500K	D. 95x33mm	Plástico + Policarbonato	IP20	Diam. Emp. 8.5cm/Incluye driver
WDO-005	Pánel LED Redondo 5W Blanco Cálido	5W	90-260V~50/60Hz	330LM	120°	3000K	D. 95x33mm	Plástico + Policarbonato	IP20	Diam. Emp. 8.5cm/Incluye driver
WDO-003	Pánel LED Redondo 12W Blanco Frío	12W	90-260V~50/60Hz	900LM	120°	6500K	D. 138x40mm	Plástico + Policarbonato	IP20	Diam. Emp. 12cm/Incluye driver
WDO-006	Pánel LED Redondo 12W Blanco Cálido	12W	90-260V~50/60Hz	850LM	120°	3000K	D. 138x40mm	Plástico + Policarbonato	IP20	Diam. Emp. 12cm/Incluye driver
WDO-001	Pánel LED Cuadrado Empotrable Blanco Frío	36W	90-260V~50/60Hz	3,000LM	120°	6500K	595x595x35mm	Aluminio + Policarbonato	IP20	Incluye driver y sujetadores
WDO-004	Pánel LED Rectangular Empotrable Blanco Frío	72W	90-260V~50/60Hz	6,000LM	120°	6500K	1195x595x35mm	Aluminio + Policarbonato	IP20	Incluye driver y sujetadores



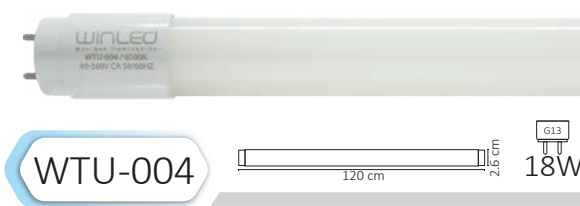
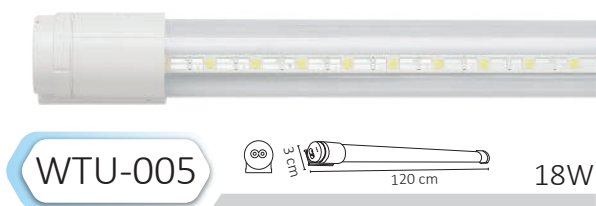
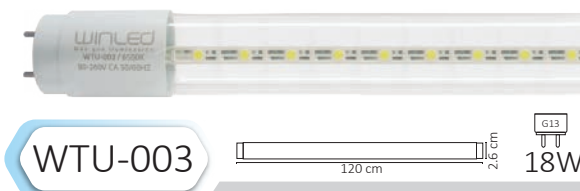
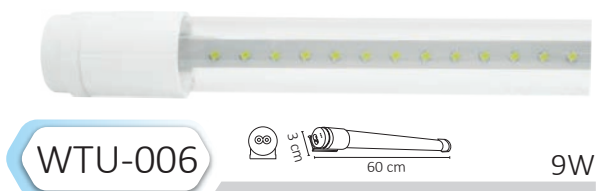
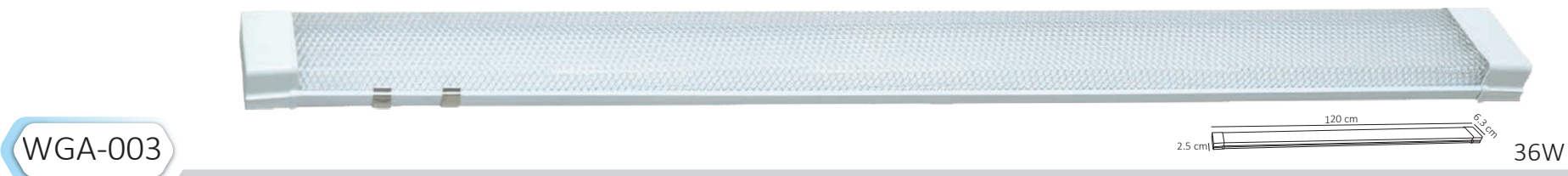

#	💡	Ⓜ	⚡	💡	360°	☀️	↔️	💎	🛡️	🔍
Código	Producto	Watts	Voltaje	Lúmenes	Apertura	Temp. Color	Dimensiones	Material	Protección	Observaciones
WGA-001	Gabinete Canaleta Doble T8 120cm	Máx. 50W	90-260V~50/60Hz	-	-	-	1217x77x40mm	Metal	IP20	P/2 Tubos T8 G13/ No Incluye Tubos
WGA-002	Gabinete Canaleta 1xT8 120cm	Máx. 50W	90-260V~50/60Hz	-	-	-	1217x57x40mm	Metal	IP20	P/1 Tubo T8 G13/ No Incluye Tubo
WGA-003	Gabinete Slim LED Integrado Tipo Regleta Escolar	36W	90-260V~50/60Hz	3,600LM	120°	6500K	1200x63x25mm	Polycarbonato	IP20	Sobreponer/ LED Integrado
WTU-006	Tubo LED Base de Plástico Transparente Blanco Frío	9W	90-260V~50/60Hz	800LM	120°	6500K	600x30mm	Vidrio + Plástico	IP20	Con Base
WTU-005	Tubo LED Base de Plástico Transparente Blanco Frío	18W	90-260V~50/60Hz	1,600LM	120°	6500K	1200x30mm	Vidrio + Plástico	IP20	Con Base
WTU-003	Tubo LED Vidrio Transparente Blanco Frío	18W	90-260V~50/60Hz	1,750LM	120°	6500K	1200x26mm	Vidrio + Plástico	IP20	Conexión 2 Polos
WTU-004	Tubo LED Vidrio Opalino Blanco Frío	18W	90-260V~50/60Hz	1,700LM	150°	6500K	1200x26mm	Vidrio Opalino + Plástico	IP20	Conexión 2 Polos
WTU-007	Tubo LED -1 PIN- Transparente T8 Blanco Frío	36W	90-260V~50/60Hz	3,000LM	120°	6500K	2400x30mm	Vidrio + Plástico	IP20	Incluye Aro Sujetador

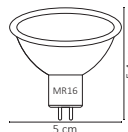

WLA-012



WLA-013

3W

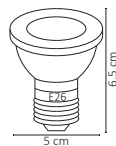

WLA-005



3W

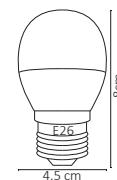

WLA-006



WLA-007

3W

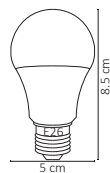

WLA-001



WLA-008

5W

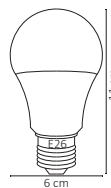

WLA-002



WLA-009

10W



Código	Producto	Watts	Voltaje	Lúmenes	Apertura	Temp. Color	Dimensiones	Material	Protección	Observaciones
WLA-012	Lámpara LED Spot MR16 Blanco Frío	3W	100-140V~50/60Hz	270LM	120°	6500K	50x55mm	Plástico	IP20	MR16 Multivoltaje
WLA-013	Lámpara LED Spot MR16 Blanco Cálido	3W	100-140V~50/60Hz	250LM	120°	3000K	50x55mm	Plástico	IP20	MR16 Multivoltaje
WLA-005	Lámpara LED Spot E26 RGB	3W	90-260V~50/60Hz	200LM	30°	Multicolor	50x65mm	Aluminio + Plástico	IP20	E26 / Incluye Control
WLA-006	Lámpara LED Bulbo E26 Blanco Frío	3W	100-140V~50/60Hz	250LM	220°	6500K	45x80mm	Aluminio + Plástico + PC	IP20	E26
WLA-007	Lámpara LED Bulbo E26 Blanco Cálido	3W	100-140V~50/60Hz	230LM	220°	3000K	45x80mm	Aluminio + Plástico + PC	IP20	E26
WLA-001	Lámpara LED Bulbo E26 Blanco Frío	5W	100-140V~50/60Hz	430LM	220°	6500K	50x85mm	Aluminio + Plástico + PC	IP20	E26
WLA-008	Lámpara LED Bulbo E26 Blanco Cálido	5W	100-140V~50/60Hz	400LM	220°	3000K	50x85mm	Aluminio + Plástico + PC	IP20	E26
WLA-002	Lámpara LED Bulbo E26 Blanco Frío	10W	100-140V~50/60Hz	850LM	220°	6500K	60x110mm	Aluminio + Plástico + PC	IP20	E26
WLA-009	Lámpara LED Bulbo E26 Blanco Cálido	10W	100-140V~50/60Hz	800LM	220°	3000K	60x110mm	Aluminio + Plástico + PC	IP20	E26



WLA-014

WLA-015



**3 PACK**

3 de 10W



WLA-010

20W

#	💡	W	⚡	☀️	360°	🌞	📏	💎	🛡️	🔍
Código	Producto	Watts	Voltaje	Lúmenes	Apertura	Temp. Color	Dimensiones	Material	Protección	Observaciones
WLA-014	Foco Lámpara 3 Pack LED Bulbo E26 10W Blanco Frío	3 x 10W	100-140V~50/60Hz	850LM	220°	6500K	60x110mm	Aluminio + Plástico + PC	IP20	Incluye 3 Lámparas
WLA-015	Foco Lámpara 3 Pack LED Bulbo E26 10W Blanco Cálido	3 x 10W	100-140V~50/60Hz	800LM	220°	3000K	60x110mm	Aluminio + Plástico + PC	IP20	Incluye 3 Lámparas
WLA-010	Lámpara Industrial LED E26 Blanco Frío	20W	90-260V~50/60Hz	1,700LM	150°	6500K	80x152mm	Aluminio + Policarbonato	IP20	Base E26



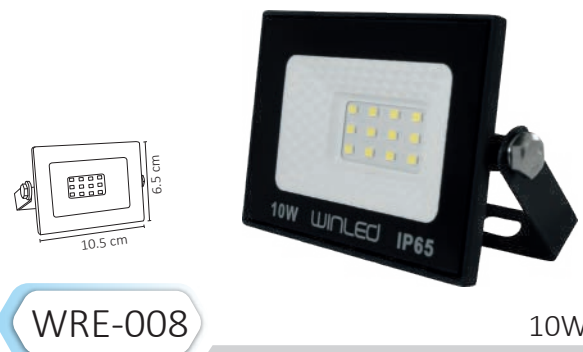
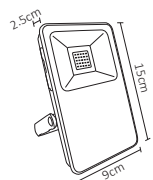

#	Lightbulb	W	Lightning bolt	Gear	360°	Lightbulb	Double-headed arrow	Diamond	Shield	Magnifying glass
Código	Producto	Watts	Voltaje	Lúmenes	Apertura	Temp. Color	Dimensiones	Material	Protección	Observaciones
WRE-004	Reflector LED 10W SMD RGB con Control Remoto	10W	90-260V~50/60Hz	Máx. 700LM	220°	Multicolor	90x70x28mm	Aluminio + Vidrio	IP65	Incluye Control
WRE-006	Reflector LED 50W SMD RGB con Control Remoto	50W	90-260V~50/60Hz	Máx 3,000LM	220°	Multicolor	178x150x28mm	Aluminio + Vidrio	IP65	Incluye Control
WRE-015	Reflector LED 100W SMD RGB con Control Remoto	100W	90-260V~50/60Hz	Máx 6,000LM	220°	Multicolor	250x215x30mm	Aluminio + Vidrio	IP65	Incluye Control
WRE-011	Reflector SMD Portatil Recargable USB	10W	90-260V~50/60Hz	Máx. 800LM	120°	6500K	150x90x25mm	Plástico + Vidrio	IP54	Batería Portatil y USB. Cambio de Intensidad y Colores (Azul y Rojo)
WRE-008	Reflector LED SMD Cuadrado Blanco Frío Exterior	10W	90-260V~50/60Hz	850LM	120°	6500K	105x65x25mm	Aluminio + Vidrio	IP65	Fácil Instalación
WRE-009	Reflector LED SMD Cuadrado Blanco Frío Exterior	20W	90-260V~50/60Hz	1700LM	120°	6500K	86x110x27mm	Aluminio + Vidrio	IP65	Fácil Instalación

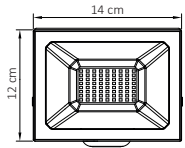

WRE-012

30W

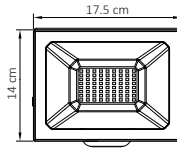

WRE-013

50W

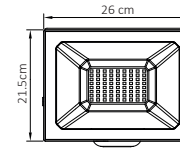

WRE-014

100W

120  
LM/W  
EFICIENCIA

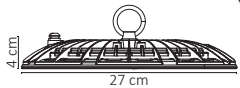

WRE-007

100W

120  
LM/W  
EFICIENCIA

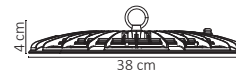

WRE-010

200W

#	💡	Ⓜ	⚡	⚙️	360°	🌞	↔️	💎	🛡️	🔍
Código	Producto	Watts	Voltaje	Lúmenes	Apertura	Temp. Color	Dimensiones	Material	Protección	Observaciones
WRE-012	Reflector LED SMD Cuadrado Blanco Frío Exterior	30W	90-260V~50/60Hz	2,550LM	120°	6500K	140x120x28mm	Aluminio + Vidrio	IP65	Fácil Instalación
WRE-013	Reflector LED SMD Cuadrado Blanco Frío Exterior	50W	90-260V~50/60Hz	4,250LM	120°	6500K	175x140x28mm	Aluminio + Vidrio	IP65	Fácil Instalación
WRE-014	Reflector LED SMD Cuadrado Blanco Frío Exterior	100W	90-260V~50/60Hz	9,000LM	120°	6500K	215x260x30mm	Aluminio + Vidrio	IP65	Fácil Instalación
WRE-007	Campana LED Slim Grafeno Multivoltaje Exterior	100W	90-277V~50/60Hz	12,000LM	90°	6500K	D. 270x40mm	Aluminio + PC	IP66	Fácil Instalación
WRE-010	Campana LED Slim Grafeno Multivoltaje Exterior	180W	90-277V~50/60Hz	24,000LM	90°	6500K	D. 380x40mm	Aluminio + PC	IP66	Fácil Instalación

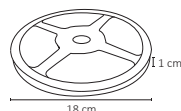

WTI-001

36W

RGB MULTICOLOR

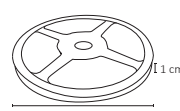

WTI-002

72W

RGB MULTICOLOR

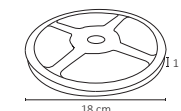

WTI-012

72W

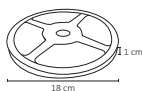

WTI-003

WTI-004

72W

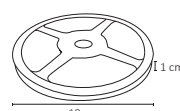

WTI-005

24W

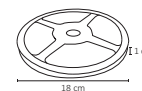

WTI-006

WTI-007

24W



Código	Producto	Watts	Voltaje	Lúmenes	Apertura	Temp. Color	Dimensiones	Material	Protección	Observaciones
WTI-001	Tira 150 LEDs 5050 Exterior RGB	36W	12V==	900-1,800LM	120°	Multicolor	5000x10x2mm	Cubierta de Silicón	IP65	*Atenuable / Corte cada 3 leds
WTI-002	Tira 300 LEDs 5050 Exterior RGB	72W	12V==	700-3,500LM	120°	Multicolor	5000x10x2mm	Cubierta de Silicón	IP65	*Atenuable / Corte cada 3 leds
WTI-012	Tira 300 LEDs 5050 Interior Blanco Frío	72W	12V==	3,600LM	120°	6500K	5000x10x2mm	Tira Flexible Adhesiva	IP20	*Atenuable / Sin Recubrimiento
WTI-003	Tira 300 LEDs 5050 Exterior Blanco Frío	72W	12V==	3,600LM	120°	6500K	5000x10x2mm	Cubierta de Silicón	IP65	*Atenuable / Corte cada 3 leds
WTI-004	Tira 300 LEDs 5050 Exterior Blanco Cálido	72W	12V==	3,400LM	120°	3000K	5000x10x2mm	Cubierta de Silicón	IP65	*Atenuable / Corte cada 3 leds
WTI-005	Tira 300 LEDs 2835 Interior Blanco Frío	24W	12V==	1,300LM	120°	6500K	5000x10x2mm	Tira Flexible Adhesiva	IP20	*Atenuable / Sin Recubrimiento
WTI-006	Tira 300 LEDs 2835 Exterior Blanco Frío	24W	12V==	1,300LM	120°	6500K	5000x10x2mm	Cubierta de Silicón	IP65	*Atenuable / Corte cada 3 leds
WTI-007	Tira 300 LEDs 2835 Exterior Blanco Cálido	24W	12V==	1,250LM	120°	3000K	5000x10x2mm	Cubierta de Silicón	IP65	*Atenuable / Corte cada 3 leds



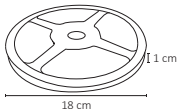

**WTI-008**

LUZ AZUL



24W

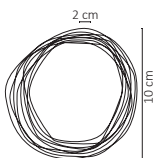

**WTI-017**

**WTI-016**



2W

## PERFILES DE ALUMINIO



**WAC-020**

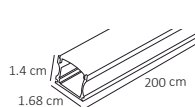

**WAC-019**



DISCRETO  
SIN BORDES



**WAC-025**

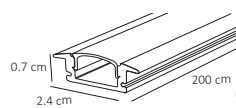

**WAC-024**

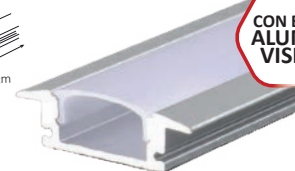

CON BORDES  
ALUMINIO  
VISIBLES



**WAC-027**

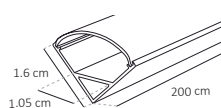

**WAC-026**

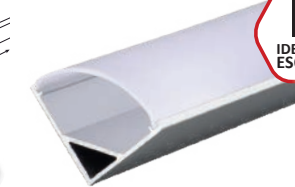

90°  
IDEAL PARA  
ESQUINAS

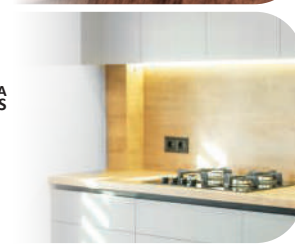

**WAC-029**

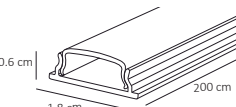

**WAC-028**



FLEXIBLE



Código	Producto	Watts	Voltaje	Lúmenes	Apertura	Temp. Color	Dimensiones	Material	Protección	Observaciones
WTI-008	Tira 300 LEDs 2835 5M 24W Exterior Azul	24W	12V==	280LM	120°	Azul	5000x8x2mm	Cubierta de Silicón	IP65	*Atenuable / Corte cada 3 leds
WTI-016	Tira LED Arroz 10M 2W Exterior Blanco Cálido	2W	12V==	130LM	120°	3000K	10000x3mm	Cable de Cobre + Silicón	IP65	12 Volts CD / *Atenuable
WTI-017	Tira LED Arroz 10M 2W Exterior Blanco Frío	2W	12V==	130LM	120°	6500K	10000x3mm	Cable de Cobre + Silicón	IP65	12 Volts CD / *Atenuable
WAC-019	Perfil de Aluminio con Cubierta Opalina Tira LED	-	-	-	-	-	2000x14x168mm	Aluminio + PC	IP20	Perfil para Tira LED
WAC-020	Kit de Instalación Perfil Aluminio para Tira LED	-	-	-	-	-	16.8x14mm	Lámina y Plástico	IP20	2 Tapones y 2 Grapas (WAC-019)
WAC-024	Perfil de Aluminio Rectangular para Tira LED	-	-	-	-	-	2000x24x70mm	Aluminio + PC	IP20	Perfil para Tira LED
WAC-025	Kit de Instalación Perfil Aluminio para Tira LED	-	-	-	-	-	16.8x7mm	Lámina y Plástico	IP20	10 Tapones y 10 Grapas (WAC-024)
WAC-026	Perfil de Aluminio con Cubierta Opalina Tira LED	-	-	-	-	-	2000x10.5x16mm	Aluminio + PC	IP20	Perfil para Tira LED
WAC-027	Kit de Instalación Perfil Aluminio para Tira LED	-	-	-	-	-	16x10.5mm	Lámina y Plástico	IP20	10 Tapones y 10 Grapas (WAC-026)
WAC-028	Perfil de Aluminio con Cubierta Opalina Tira LED	-	-	-	-	-	2000x18x60mm	Aluminio + PC	IP20	Perfil para Tira LED
WAC-029	Kit de Instalación Perfil Aluminio para Tira LED	-	-	-	-	-	60x18mm	Lámina y Plástico	IP20	10 Tapones y 10 Grapas (WAC-028)



INTERIOR

WTI-013

WTI-014

WTI-015

72W



24V

PROTECCIÓN  
IP20  
INTERIOR



\*Requiere atenuador compatible a 24V.



WTI-018

WTI-019

55W



12V

PROTECCIÓN  
IP20  
INTERIOR



\*Requiere atenuador compatible a 12V.

INTERIOR

WTI-020

WTI-021

55W



12V

PROTECCIÓN  
IP67  
EXTERIOR



\*Requiere atenuador compatible a 12V.

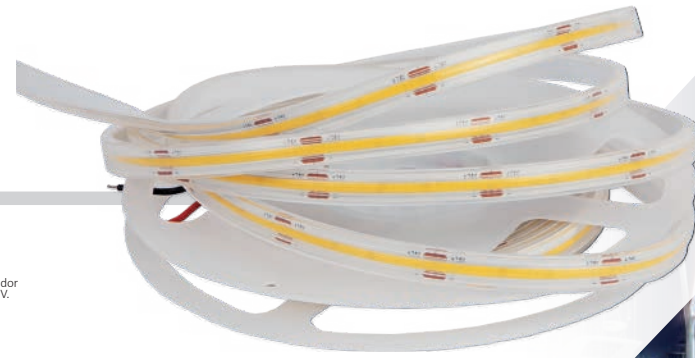

EXTERIOR

#	Producto	Watts	Voltaje	Lúmenes	Apertura	Temp. Color	Dimensiones	Material	Protección	Observaciones
WTI-013	Tira LED COB Continuo 5M 72W Blanco Cálido	72W	24V	6,000LM	120°	3000K	5000x10mm	Tira Flexible Adhesiva	IP20	24 Volts CD / *Atenuable
WTI-014	Tira LED COB Continuo 5M 72W Blanco Neutro	72W	24V	6,000LM	120°	4000K	5000x10mm	Tira Flexible Adhesiva	IP20	24 Volts CD / *Atenuable
WTI-015	Tira LED COB Continuo 5M 72W Blanco Frío	72W	24V	6,000LM	120°	6500K	5000x10mm	Tira Flexible Adhesiva	IP20	24 Volts CD / *Atenuable
WTI-018	Tira LED COB Continuo 5M 55w Blanco Frío	55W	12V	4,000LM	120°	6500K	5000x8mm	Tira Flexible Adhesiva	IP20	12 Volts CD / *Atenuable
WTI-019	Tira LED COB Continuo 5M 55w Blanco Cálido	55W	12V	4,000LM	120°	3000K	5000x8mm	Tira Flexible Adhesiva	IP20	12 Volts CD / *Atenuable
WTI-020	Tira LED COB Continuo Silicón Flexible Blanco Frío	55W	12V	4,000LM	120°	6500K	5000x8mm	Tira Flexible Adhesiva	IP67	12 Volts CD / *Atenuable
WTI-021	Tira LED COB Continuo Silicón Flexible Blanco Cálido	55W	12V	4,000LM	120°	3000K	5000x8mm	Tira Flexible Adhesiva	IP67	12 Volts CD / *Atenuable

# TIRAS LED NEON

**WINLED**  
Más que Iluminación

WTI-022

48W



12V

PROTECCIÓN  
IP65  
EXTERIOR



\*Requiere atenuador compatible a 12V.

WTI-023

48W



12V

PROTECCIÓN  
IP65  
EXTERIOR



\*Requiere atenuador compatible a 12V.

EXTERIOR

EXTERIOR



#	Lightbulb	W	Lightning Bolt	Lightbulb	360°	Color Wheel	Double Arrow	Diamond	Shield	Magnifying Glass
Código	Producto	Watts	Voltaje	Lúmenes	Apertura	Temp. Color	Dimensiones	Material	Protección	Observaciones
WTI-022	Tira LED NEÓN Flexible 48W Exterior Blanco Frío	48W	12V	1,250LM	150°	6500K	5000x6x12mm	Silicón	IP65	Corte cada 2.5 cms
WTI-023	Tira LED NEÓN Flexible 48W Exterior Rosa	48W	12V	1,000LM	150°	Rosa	5000x6x12mm	Silicón	IP65	Corte cada 2.5 cms



Iluminación de Caminata



WTI-024

WTI-025

24W



\*Requiere atenuador compatible a 24V.



WAC-023

## Controlador y Control

**28 PROGRAMAS PREESTABLACIDOS**

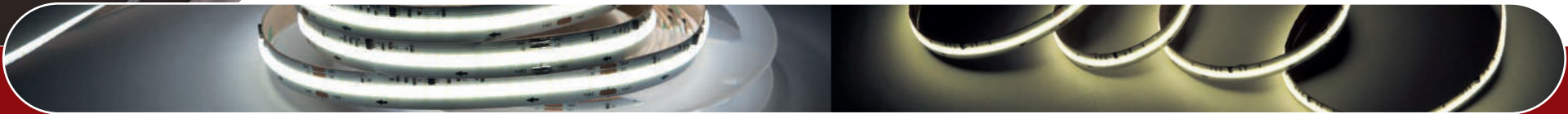

#	Producto	Watts	Voltaje	Lúmenes	Apertura	Temp. Color	Dimensiones	Material	Protección	Observaciones
WTI-024	Tira LED COB DIGITAL Continuo Blanco Frío	60W	24V==	4,000LM	150°	6500K	5000x3x10mm	Tira Flexible Adhesiva	IP20	24 Volts CD / *Atenuable
WTI-025	Tira LED COB DIGITAL Continuo Blanco Cálido	60W	24V==	4,000LM	150°	3000K	5000x3x10mm	Tira Flexible Adhesiva	IP20	24 Volts CD / *Atenuable
WAC-023	Controlador y Control para tira Caminata	-	24V==	-	-	-	-	-	-	Con un controlador puedes manipular hasta 100m de tira

# TIRA LED PIXEL

**WINLED**  
Más que Iluminación

**PROGRAMABLE PARA  
SECUENCIAS O LINEAMIENTOS**

**WTI-026**

72W



12V

PROTECCIÓN  
IP20  
EXTERIOR



\*Requiere atenuador compatible a 12V.

## Control y Controlador

**CON MÁS DE 200  
PROGRAMAS  
PRESTABLECIDOS**



**WAC-030**



Código



Producto



Watts



Voltaje



Lúmenes



Apertura



Temp.  
Color



Dimensiones



Material



Protección



Observaciones

WTI-026	Tira LED PIXEL 5M RGB Multicolor	72W	12V	3,500LM	120°	RGB	5000x6x12mm	PCB Negro	IP20	Requiere controlador (WAC-030)
WAC-030	Mini Controlador FR y Control Remoto para tira PIXEL	-	5V-12V	-	-	-	0x0x0mm	-	-	Compatible con WTI-026





**10**  
 METROS  
 POR ROLLO

**60**  
 LED/M  
 2835

**25**  
 METROS  
 POR ROLLO

**60**  
 LED/M  
 2835

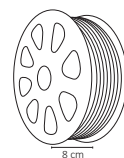
**25**  
 METROS  
 POR ROLLO

**60**  
 LED/M  
 2835

**25**  
 METROS  
 POR ROLLO

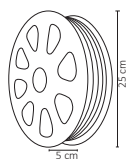
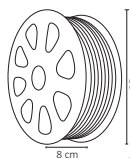
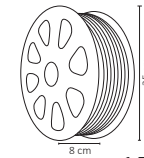
**120**  
 LED/M  
 2835

**WMA-012**

**40W**
**WMA-006**

**100W**
**WMA-008**
**WMA-009**
**WMA-010**
**WMA-011**
**100W**
**WMA-014**

**150W**

Código	Producto	Watts	Voltaje	Lúmenes	Apertura	Temp. Color	Dimensiones	Material	Protección	Observaciones
WMA-012	Manguera LED 2835 10m Exterior Blanco Frío	40W	127V~50/60Hz	2,800LM	120°	6500K	10000x11x6.5mm	Silicón	IP65	Se Puede Cortar Cada 1 Metro
WMA-013	Manguera LED 2835 10m Exterior Blanco Cálido	40W	127V~50/60Hz	2,720LM	120°	3000K	10000x11x6.5mm	Silicón	IP65	Se Puede Cortar Cada 1 Metro
WMA-006	Manguera LED 2835 25m Exterior Blanco Frío	100W	127V~50/60Hz	7,000LM	120°	6500K	25000x11x6.5mm	Silicón	IP65	Se Puede Cortar Cada 1 Metro
WMA-007	Manguera LED 2835 25m Exterior Blanco Cálido	100W	127V~50/60Hz	6,800LM	120°	3000K	25000x11x6.5mm	Silicón	IP65	Se Puede Cortar Cada 1 Metro
WMA-008	Manguera LED 2835 25m Exterior Azul	100W	127V~50/60Hz	1,750LM	120°	Azul	25000x11x6.5mm	Silicón	IP65	Se Puede Cortar Cada 1 Metro
WMA-009	Manguera LED 2835 25m Exterior Rojo	100W	127V~50/60Hz	2,300LM	120°	Rojo	25000x11x6.5mm	Silicón	IP65	Se Puede Cortar Cada 1 Metro
WMA-010	Manguera LED 2835 25m Exterior Verde	100W	127V~50/60Hz	3,500LM	120°	Verde	25000x11x6.5mm	Silicón	IP65	Se Puede Cortar Cada 1 Metro
WMA-011	Manguera LED 2835 25m Exterior Amarillo	100W	127V~50/60Hz	3,500LM	120°	Amarillo	25000x11x6.5mm	Silicón	IP65	Se Puede Cortar Cada 1 Metro
WMA-014	Manguera Doble LED 2835 25m Blanco Frío	150W	127V~50/60Hz	10,500LM	120°	6500K	25000x11x6.5mm	Silicón	IP65	Se Puede Cortar Cada 1 Metro
WMA-015	Manguera Doble LED 2835 25m Blanco Cálido	150W	127V~50/60Hz	10,500LM	120°	3000K	25000x11x6.5mm	Silicón	IP65	Se Puede Cortar Cada 1 Metro

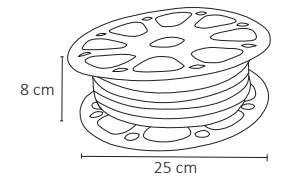
\*Para atenuar las mangueras LED se requiere el accesorio WAC-016 (se vende por separado).



\*Colores de mangueras simulando el color de luz.



150W

WMA-016

WMA-017

WMA-018

WMA-019

WMA-020

#	💡	W	⚡	☀️	360°	🔧	📏	💎	🛡️	🔍
Código	Producto	Watts	Voltaje	Lúmenes	Apertura	Temp. Color	Dimensiones	Material	Protección	Observaciones
WMA-016	Manguera Neón Doble LED 2835 25m Blanco Frío	150W	127V~50/60Hz	10,500LM	150°	6500K	25000x9x14mm	Silicón	IP65	Neón / Corte Cada 50cm.
WMA-017	Manguera Neón Doble LED 2835 25m Blanco Cálido	150W	127V~50/60Hz	10000LM	150°	3000K	25000x9x14mm	Silicón	IP65	Neón / Corte Cada 50cm.
WMA-018	Manguera Neón Doble LED 2835 25m Verde	150W	127V~50/60Hz	5,250LM	150°	Verde	25000x9x14mm	Silicón	IP65	Neón / Corte Cada 50cm.
WMA-019	Manguera Neón Doble LED 2835 25m Azul	150W	127V~50/60Hz	2,250LM	150°	Azul	25000x9x14mm	Silicón	IP65	Neón / Corte Cada 50cm.
WMA-020	Manguera Neón Doble LED 2835 25m Rojo	150W	127V~50/60Hz	2,250LM	150°	Rojo	25000x9x14mm	Silicón	IP65	Neón / Corte Cada 50cm.



WMO-001

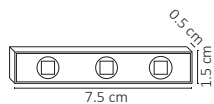

0.72W



WMO-008

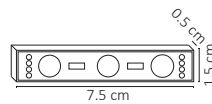

0.72W



WMO-010

WMO-011

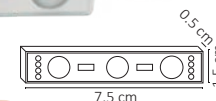

WMO-012

WMO-013

0.72W



WMO-014

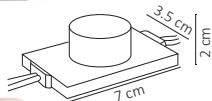

1.4W

WMO-015

WMO-016



WMO-017

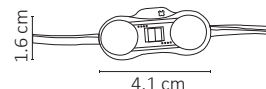

1W

WMO-018

WMO-019



WMO-020

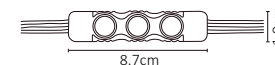

1.6W

WMO-021



Código	Producto	Watts	Voltaje	Lúmenes	Apertura	Temp. Color	Dimensiones	Material	Protección	Observaciones
WMO-001	Módulo 3 LEDs SMD 5050 Exterior RGB	0.72W	12V=	15-40LM	120°	Multicolor	75x15x5mm	Plástico + Policarbonato	IP65	RGB
WMO-008	Módulo 3 LEDs SMD 2835 Exterior Blanco Frío	0.72W	12V=	60LM	120°	6500K	75x15x5mm	Plástico + Policarbonato	IP65	Blanco Frío
WMO-009	Módulo 3 LEDs SMD 2835 Exterior Blanco Cálido	0.72W	12V=	55LM	120°	3000K	75x15x5mm	Plástico + Policarbonato	IP65	Blanco Cálido
WMO-010	Módulo 3 LEDs SMD 2835 Exterior Azul	0.72W	12V=	15LM	120°	Azul	75x15x5mm	Plástico + Policarbonato	IP65	Azul
WMO-011	Módulo 3 LEDs SMD 2835 Exterior Rojo	0.72W	12V=	20LM	120°	Rojo	75x15x5mm	Plástico + Policarbonato	IP65	Rojo
WMO-012	Módulo 3 LEDs SMD 2835 Exterior Verde	0.72W	12V=	30LM	120°	Verde	75x15x5mm	Plástico + Policarbonato	IP65	Verde
WMO-013	Módulo 3 LEDs SMD 2835 Exterior Amarillo	0.72W	12V=	30LM	120°	Amarillo	75x15x5mm	Plástico + Policarbonato	IP65	Amarillo
WMO-014	Módulo Super LED con Óptica Exterior Blanco Frío	1.4W	12V=	130LM	120°	6500K	70x35x20mm	Plástico + Policarbonato	IP65	Blanco Frío
WMO-015	Módulo Super LED con Óptica Exterior Azul	1.4W	12V=	25LM	120°	Azul	70x35x20mm	Plástico + Policarbonato	IP65	Azul
WMO-016	Módulo Super LED con Óptica Exterior Rojo	1.4W	12V=	30LM	120°	Rojo	70x35x20mm	Plástico + Policarbonato	IP65	Rojo
WMO-017	Módulo LED x2 Samsung SMD 2835 Blanco Cálido	1W	12V=	100LM	120°	3000K	16x41mm	Plástico + Policarbonato	IP67	Blanco Cálido
WMO-018	Módulo LED x2 Samsung SMD 2835 Blanco Neutro	1W	12V=	100LM	150°	4000K	16x41mm	Plástico + Policarbonato	IP67	Blanco Neutro
WMO-019	Módulo LED x2 Samsung SMD 2835 Blanco Frío	1W	12V=	100LM	150°	6500K	16x41mm	Plástico + Policarbonato	IP67	Blanco Frío
WMO-020	Módulo LED 3xSMD 2835 Blanco Frío	1.6W	100-135V~50/60Hz	115LM	150°	6500K	87x19x9mm	Plástico + Policarbonato	IP67	Trabajan de 2 en 2
WMO-021	Módulo LED 3xSMD 2835 Blanco Cálido	1.6W	100-135V~50/60Hz	115LM	120°	3000K	87x19x9mm	Plástico + Policarbonato	IP67	Trabajan de 2 en 2





12V  
80%  
Eficiencia

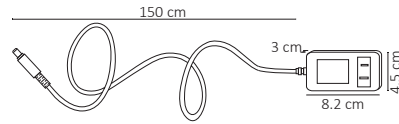

WEL-001

24W

12V  
80%  
Eficiencia

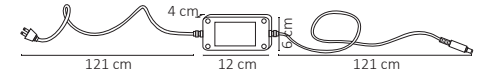

WEL-002

60W



12V  
90%  
Eficiencia

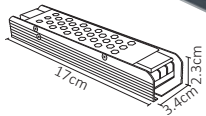

WEL-005

60W



12V  
90%  
Eficiencia

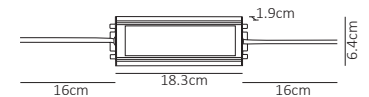

WEL-006

100W

#	💡	W	⚡	🔌	⚙️	📏	💎	🛡️	🔍
Código	Producto	Watts	Voltaje	Voltaje de Salida	Eficiencia	Dimensiones	Material	Protección	Observaciones
WEL-001	Eliminador de Voltaje CD 12V a 2A Interior	24W	90-260V~50/60Hz	12V=	80%	82x45x30mm	Plástico	IP20	Med. del Cable: 150cm
WEL-002	Eliminador de Voltaje CD 12V a 5A Interior	60W	90-260V~50/60Hz	12V=	80%	120x60x40mm	Plástico	IP20	Med. de los Cables: 121cm c/u
WEL-005	Fuente de Poder CD 12V a 5A Aluminio Interior	60W	90-260V~50/60Hz	12V=	90%	170x34x23mm	Aluminio	IP20	Compatible con Tiras 12V CD
WEL-006	Fuente de Poder CD 12V a 8.3A Aluminio Resistente	100W	90-260V~50/60Hz	12V=	90%	183x64x19mm	Aluminio	IP67	Med. de los Cables 16cm c/u

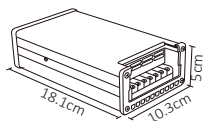

12V

IP63  
A Prueba de Lluvias90%  
Eficiencia

WEL-007

200W

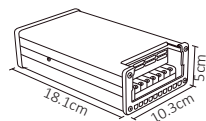

12V

IP63  
A Prueba de Lluvias90%  
Eficiencia

WEL-008

350W

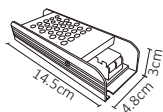

24V

90%  
Eficiencia

WEL-011

100W

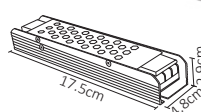

12V

90%  
Eficiencia

WEL-012

150W



Código	Producto	Watts	Voltaje	Voltaje de Salida	Eficiencia	Dimensiones	Material	Protección	Observaciones
WEL-007	Fuente de Poder CD 12V a 16.7A Aluminio Impermeable	200W	90-140V~50/60Hz	12V	90%	181x103x50mm	Alum. Impermeable	IP63	A prueba de Lluvias
WEL-008	Fuente de Poder CD 12V a 16.7A Aluminio Impermeable	200W	90-140V~50/60Hz	12V	90%	181x103x50mm	Alum. Impermeable	IP63	A Prueba de Lluvias
WEL-011	Fuente de Poder CD 24V a 29.16A Aluminio	350W	90-140V~50/60Hz	24V	90%	145x48x30mm	Aluminio	IP20	Compatible con WTI-013/014/015 / 24V
WEL-012	Fuente de Poder CD 12V a 12.5A Aluminio	150W	90-140V~50/60Hz	12V	90%	175x48x29mm	Aluminio	IP20	Para Interiores / Para Tiras de 12V

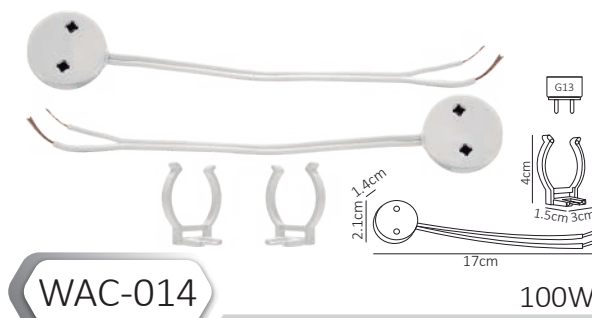
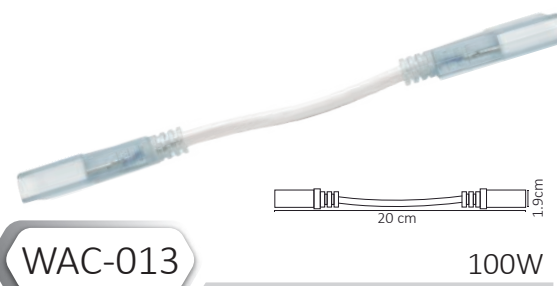
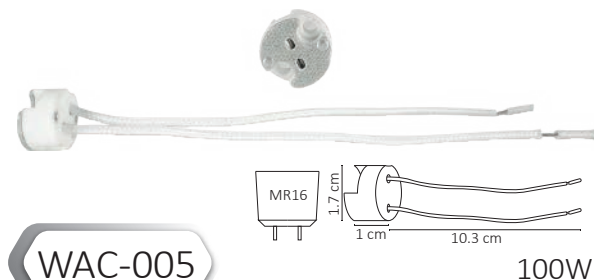
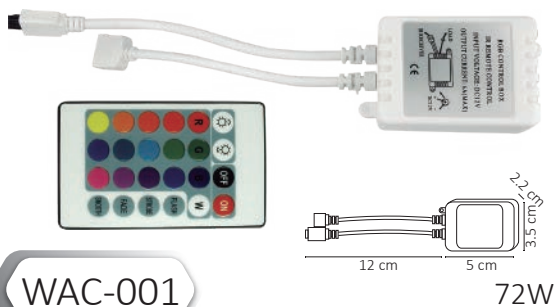

Código	Producto	Watts	Voltaje	Lúmenes	Apertura	Temp. Color	Dimensiones	Material	Protección	Observaciones
WAC-001	Controlador Tira RGB con Control de 16 Colores	72W	12V===	-	-	-	50x35x22mm	Plástico	IP20	Incluye Control con Batería
WAC-002	Amplificador Tira RGB Slim Interior	72W	12V===	-	-	-	162x13mm	Plástico	IP20	Amplificador
WAC-005	Conector Base MR16 Plástico con Cable	100W	90-260V~50/60Hz	-	-	-	17x10mm	Cerámica	IP20	Medida del Cable: 10.3cm
WAC-006	Conector Base GU10 Cerámica con Cable	100W	90-260V~50/60Hz	-	-	-	28x16mm	Cerámica	IP20	Medida del Cable: 7.2cm
WAC-007	Conector Base G13 para Tubo T8	100W	90-260V~50/60Hz	-	-	-	38x38mm	Plástico	IP20	Base para Tubo G13
WAC-012	Conector Simple Kit para 50M Manguera 2835 CA 127V Exterior	Max. 200W	127V~50/60Hz	-	-	-	470x33mm	Plástico	IP65	Para Conectar Manguera 127V
WAC-013	Conector Extensión Manguera 2835 20cm Exterior	100W	127V~50/60Hz	-	-	-	200x19mm	Plástico	IP65	Para Interconectar 2 Mangueras
WAC-014	Kit de Conexión de Tubo LED	100W	90-260V~50/60Hz	-	-	-	170x21x14mm	Plástico	IP20	Para Tubo G13
WAC-015	Clip de Plástico para Fijación de Manguera	Máx. 100W	-	-	-	-	35x10x7mm	Plástico	IP65	Kit de 10 Piezas

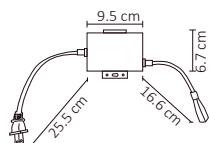
PARA  
 MANGUERA

**WAC-016**

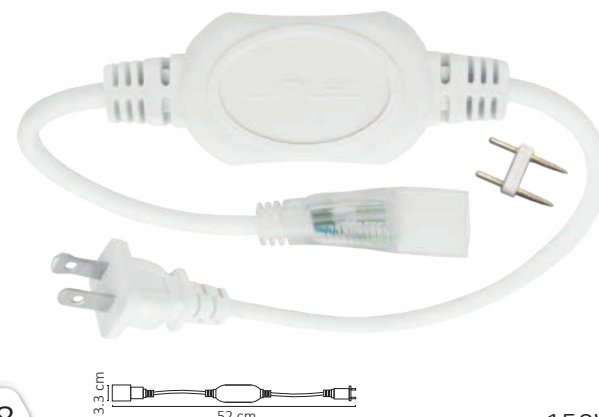
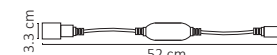

500W

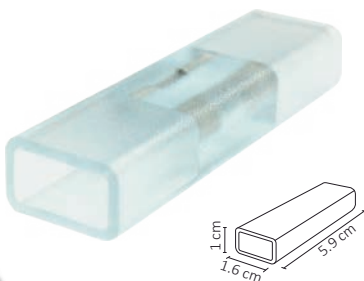
 PARA  
 MANGUERA  
 NEÓN

**WAC-018**

150W

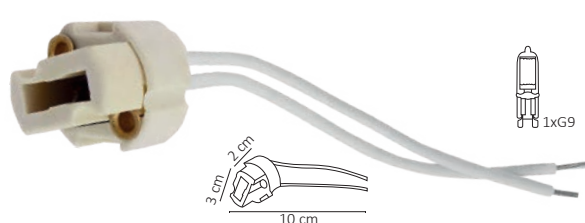
**WAC-017**

100W

**WAC-021**

Máx. 50W

**WAC-022**

Máx. 50W



Código	Producto	Watts	Voltaje	Dimensiones	Material	Protección	Observaciones
WAC-016	Atenuador RF para Manguera LED con Control	Máx. 500W	127V~50/60Hz	95x25x67mm	Aluminio	IP20	Med. Cable: 25.5cm y 16.6cm
WAC-017	Conector Medio para Manguera LED	Máx. 100W	127V~50/60Hz	16x59x10mm	Plástico + Pin de Metal	IP65	Incluye 2 Pines
WAC-018	Conector Simple para Manguera Neón	Máx. 300W	127V~50/60Hz	520x33mm	Plástico	IP65	Para Manguera Neón
WAC-019	Perfil de Aluminio Anodizado con Cubierta PC Opalina para Tira LED	-	-	2000x143x168mm	Aluminio + PC	IP20	Perfil para Tira LED
WAC-020	Kit de Instalación Perfil Aluminio para Tira LED	-	-	16.8x14.3mm	Lámina y Plástico	IP20	Accesorio para WAC-019 2 Tapones y 2 Grapas
WAC-021	Conector G9	Máx. 50W	90-260V~50/60Hz	100x20x30mm	Cerámica	IP20	Cable 14cm
WAC-022	Contratuercas Base E26	Máx. 50W	90-260V~50/60Hz	54x52mm	Plástico	IP20	Base E26



WAD-001

Máx. 50W



WAD-002

Máx. 50W



WAD-003

Máx. 50W



WAD-004

Máx. 50W

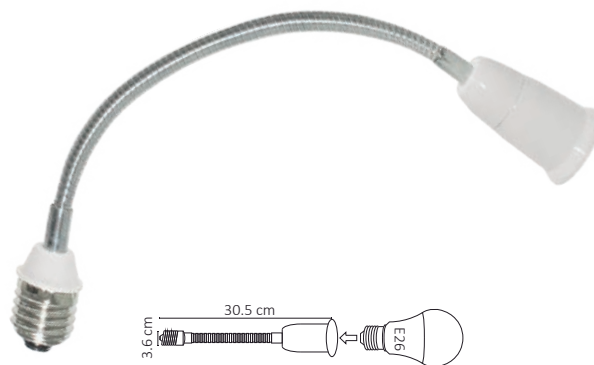

WAD-005

Máx. 50W



WAD-006

Máx. 50W

Código	Producto	Watts	Voltaje	Lúmenes	Apertura	Dimensiones	Material	Protección	Observaciones
WAD-001	Adaptador de Base E26 a Lámpara E12	Max. 50W	90-300V~50/60Hz	-	-	29x26mm	Lámina + Plástico	IP20	E26 a E12
WAD-002	Adaptador de Base E26 a Lámpara GU10	Máx. 50W	90-300V~50/60Hz	-	-	35x50mm	Lámina + Cerámica	IP20	E26 a GU10
WAD-003	Adaptador de Base E40 a Lámpara E26	Máx. 50W	90-300V~50/60Hz	-	-	45x50mm	Lámina + Plástico	IP20	E40 a E26
WAD-004	Adaptador de Base GU10 a Lámpara MR16	Máx. 50W	90-300V~50/60Hz	-	-	23x21mm	Lámina + Cerámica	IP20	GU10 a MR16
WAD-005	Adaptador Extensión Flexible 30cm de Base E26 a Lámpara E26	Máx. 50W	90-300V~50/60Hz	-	-	305x36mm	Lámina + Plástico	IP20	Extensión 30cm E26 a E26
WAD-006	Adaptador de Base E14 a Lámpara E12	Máx. 50W	90-300V50/60Hz	-	-	18x27mm	Lámina + Plástico	IP20	E14 a E12





NOM-058-SCFI-2017  
NOM-003-SCFI-2014  
NOM-030-ENER-2016  
NOM-031-ENER-2019



EN CONDICIONES  
NORMALES\*

**WINLED**  
Más que Iluminación



[www.innlite.com](http://www.innlite.com)



EN CONDICIONES  
NORMALES\*

**ar7lite**  
ILUMINACIÓN LED

Grupo INNLITE, te informa que nuestros productos se encuentran certificados bajo la **NORMA OFICIAL MEXICANA**. Cada familia de producto, requiere una o varias NOM en específico, la cual **Grupo INNLITE**, puede brindarte a solicitud expresa.  
¿Porque comprar productos certificados? El certificado de cada producto, garantiza que nuestros productos cumplen con los criterios de Calidad, Seguridad, Eficiencia y Correcto Funcionamiento, que demanda el gobierno federal, a través de sus dependencias competentes.  
Cuando utilizas Producto **AR7LITE** o **WINLED**, estas garantizando la satisfacción de tu cliente o proyecto.